



Thermo65 / Thermo46 Entrance Doors

NEW: Door style 010 with stainless steel embellishments

HÖRMANN





CONTENT

6	Good reasons to try Hörmann
10	Programme overview
12	Thermo65
22	Thermo46
34	Safety equipment
36	Automatic locks, glazings
38	Handles, Embellishments
40	Colours and surface finishes
44	Dimensions and fitting data
46	Hörmann product range

The colours and surface finishes shown are subject to the limitations of the printing process and cannot be regarded as binding.

Some of the products and equipment details described and illustrated in this catalogue are not standard, but available for a surcharge depending on the equipment option. Please contact your Hörmann Partner with reference to the current price list for specific door equipment.

Descriptions and pictures, information about the scope of delivery, equipment and colour correspond to the time of printing. Subject to changes and errors.

All rights reserved. No part may be reproduced without our prior permission.

◀ **Thermo65 Style 700** in Decograin Golden Oak, with side elements

There's no place like home

What's better than coming home after a long day at work and enjoying family life? You can eat, play board games and watch TV together. To be able to enjoy time with your loved ones, you have to feel safe and at ease in your own four walls.

Hörmann Thermo65 and Thermo46 entrance doors will help you with that. Our high-quality construction components feature excellent thermal insulation values, reliable safety equipment, a large selection of styles at an attractive price. You are sure to find a Hörmann door that meets your demands on the following pages.





“A good reputation must be earned.”

August Hörmann

In keeping with the tradition started by the company's founder, the name Hörmann delivers brand name quality with extensive product expertise. The family business has over 80 years of experience as a construction component specialist and sees itself as your partner from the very beginning of building and renovation projects. It's no surprise that Hörmann is one of Europe's most successful entrance door providers. All this makes Hörmann entrance doors a reassuring purchase.



1 Quality products from Germany

The entrance door construction is developed and manufactured by Hörmann. Our highly qualified employees work intensively on new products, continual further developments and improvements to details. Patents and unique products on the market are the result of this. Endurance tests under real conditions ensure **mature series products with Hörmann quality.**

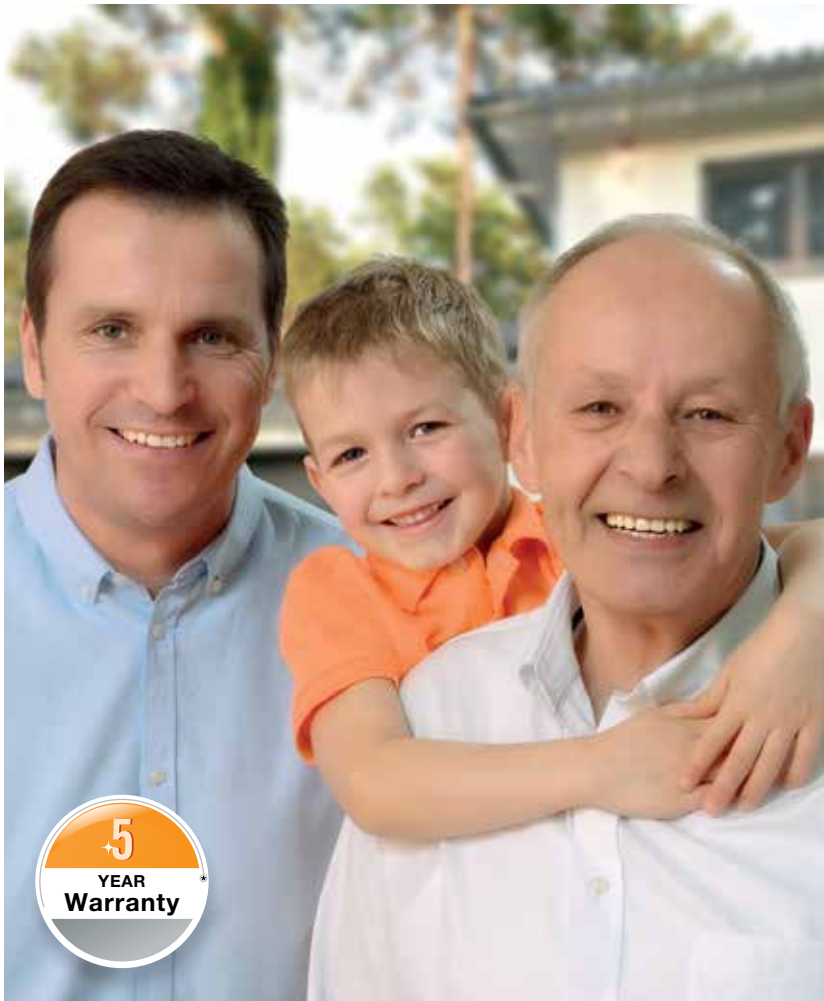

2 Entrance doors for generations

We are convinced of our products and our uncompromising quality assurance. That is why we issue a **5-year guarantee*** on **Thermo65 / Thermo46 entrance doors.**

3 An eye on the future

Hörmann is setting a good example. This is why the company has obtained **100 % of its required energy from green sources.** At the same time, many tonnes of CO₂ are saved each year thanks to the introduction of an intelligent and certified energy management system. And last but not least, Hörmann offers products for sustainable construction.

* The complete warranty conditions can be found at: www.hormann.co.uk



4 Door leaf without visible leaf profile

Thermo65 and Thermo46 doors make for an exquisite and elegant reception – whether you use them for a main or a side entrance. **The shapely door leaf with its solid interior and exterior and leaf profile on the inside fulfils the highest design requirements.** The interior view (shown on page 32) harmonises perfectly with your residential internal doors.



Doors of other manufacturers have a disturbed appearance owing to a visible leaf profile

5 High thermal insulation

With U_D -values up to approx. $1.1 \text{ W}/(\text{m}^2 \cdot \text{K})^*$, Thermo46 entrance doors provide excellent thermal insulation for your home. **Thermo65 entrance doors feature a U_D -value of up to approx. $0.87 \text{ W}/(\text{m}^2 \cdot \text{K})^*$ for even better thermal insulation.** As a result, you save energy in the long term while also protecting the environment.



6 Break-in-resistant locking

For you and your family, being able to rest easy in your own home is important. This is why our **Thermo65 / Thermo46 doors are equipped with multiple-point locking as standard.**

For even more security, many Thermo46 door styles as well as all Thermo65 entrance doors (including with side elements and transom lights) are **optionally available with break-in-resistant RC 2 security equipment.**



7 Safe glazing

When it comes to industrial safety and burglar protection, Hörmann entrance doors fulfil the highest demands. The 8-mm-thick laminated safety glass on the interior of the insulated glazing provides maximum security. In **case of breakage**, the glass splinters are bound and stay adhered to the plastic film on the inside, virtually **eliminating any danger of being injured by the shards.**

Furthermore, the laminated safety glass offers better protection against burglars as it makes reaching through more difficult.

Steel / aluminium entrance door Thermo65

Door leaf

The high-quality Thermo65 doors are equipped with a solid 65-mm-thick steel door leaf with a leaf profile on the inside and a thick rebate. Thanks to the solid door view from the inside, the doors perfectly match the timber internal doors of your home. You can enjoy the same door view of doors made of different materials for many years to come.

Leaf profile

The leaf profile made of composite material components creates a better thermal break, providing higher stability and ensuring that the door leaf never warps.

Thermal insulation

With a U_D -value of up to approx. $0.87 \text{ W}/(\text{m}^2\cdot\text{K})$, the Thermo65 version is the best when it comes to thermal insulation, saving you energy in the long term.

Break-in resistance

All Thermo65 entrance door styles, as well as side elements and transom lights, come with optional RC 2 security features. The doors are approved for being fitted opening inwards and outwards.

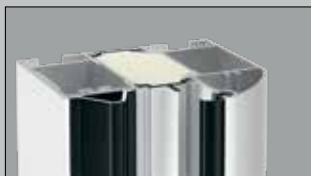

Round-style (profile A3)

Frame

The 80 mm aluminium frame with thermal break and PU foam infill is available in a round-style or rectangular profile.

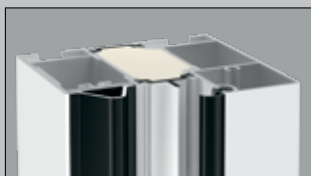

Rectangular version (profile A4)



Seal

Thermo65 doors are characterised by their well thought-out details, such as the 20-mm-high aluminium / plastic threshold with triple sealing and thermal break for improved thermal insulation.



Thermo65

U_D -value up to
approx. $0.87 \text{ W}/(\text{m}^2\cdot\text{K})$

Approved by IFT Rosenheim
Door size RAM 1230 × 2180 mm

Steel / aluminium entrance door Thermo46

Door leaf

All Thermo46 doors are equipped with a solid, 46-mm-thick interior and exterior steel door leaf with internal leaf profile and thick rebate design. The Thermo46 is delivered with a solid door leaf to give your entrance doors and residential internal doors a uniform view from the inside.

Leaf profile

The leaf profile made of composite material has a thermal break and is very stable, ensuring that the door leaf never warps.

Thermal insulation

With the PU-foamed door leaf and thanks to a thermal break, Thermo46 doors provide excellent thermal insulation for your home with a U_D -value of up to approx. $1.1 \text{ W}/(\text{m}^2 \cdot \text{K})$.

Break-in resistance

Thermo46 TPS 700 / 750 / 900 / 010 / 015 / 515 and 100 door styles come optionally without side elements and transom lights, with RC 2 safety equipment. The doors are approved for being fitted opening inwards.



Round-style (profile A1)

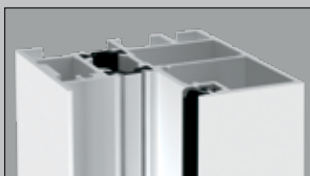

Rectangular version (profile A2)

Frame

The 60 mm aluminium frame with thermal break is available in a round-style or rectangular profile.



Seal

Save valuable energy: a 20-mm-high aluminium/plastic threshold with thermal break and double sealing reduces heat loss. The additional brush seals at the bottom provide optimum protection against bad weather.

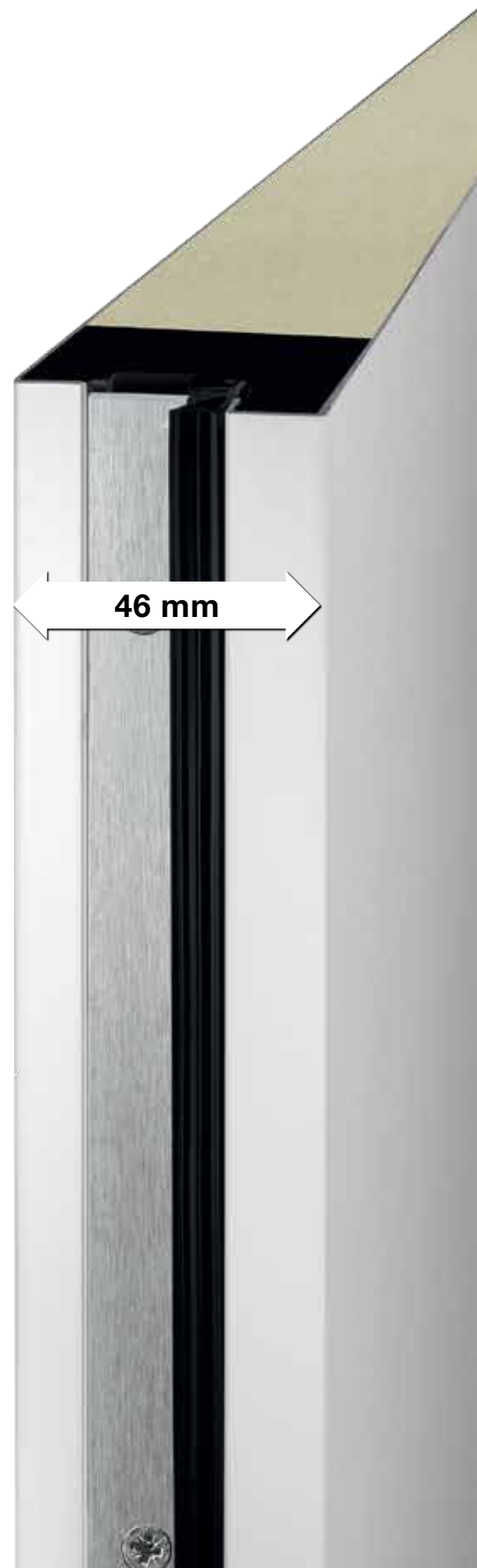

Thermo46

U_D -value up to
approx. $1.1 \text{ W}/(\text{m}^2 \cdot \text{K})$

Approved by IFT Rosenheim
Door size RAM 1230 × 2180 mm





The entrance door that makes you feel welcome

If you would like to equip your main entrance with an attractive, high-quality door, Hörmann's Thermo65 entrance door is the right choice for you. The solid 65-mm-thick steel door leaf with PU rigid foam infill and the leaf profile on the inside made of composite material keep the cold out. With a U_D -value of up to approx. $0.87 \text{ W}/(\text{m}^2 \cdot \text{K})$, Thermo65 doors feature excellent thermal insulation. As standard, the doors are equipped with a 5-point security lock, allowing you to feel safe and secure in your home. Thermo65 styles are optionally available with RC 2 safety equipment to make you feel even more secure in your own four walls.

Choose your ideal entrance door from 13 attractive styles and customise it with one of our 16 preferred colours and 5 Decograin decors.

Showcase your good taste



Style 700

Shown: preferred colour Grey aluminium RAL 9007

Stainless steel handle HB 38-2 on steel infill, full glazing: triple-pane insulated glass, exterior laminated safety glass, centre sand-blasted float with clear stripes, interior clear single-pane safety glass, U_D -value up to approx. $0.98 \text{ W}/(\text{m}^2 \cdot \text{K})^*$

Side element / transom light

Triple-pane insulated glazing, exterior laminated safety glass, centre float, interior laminated safety glass



Style 750

Shown: standard colour Traffic white, silk matt, RAL 9016

Stainless steel handle HB 38-2 on steel infill, full glazing: triple-pane insulated glass, exterior laminated safety glass, centre sand-blasted float with clear stripes, interior clear single-pane safety glass, U_D -value up to approx. $0.95 \text{ W}/(\text{m}^2 \cdot \text{K})^*$

Side element / transom light

Triple-pane insulated glazing, exterior laminated safety glass, centre float, interior laminated safety glass



Style 800

Shown: Decograin Titan Metallic CH 703
 Stainless steel handle HB 38-2 on steel infill,
 4 rectangular glazings with stainless steel frame:
 triple-pane insulated glass, exterior laminated
 safety glass, centre sand-blasted float, interior
 clear laminated safety glass, U_D -value up to
 approx. $0.93 \text{ W}/(\text{m}^2 \cdot \text{K})^*$

Side element / transom light

Triple-pane insulated glazing, exterior laminated
 safety glass, centre float, interior laminated
 safety glass



Style 810

Shown: standard colour Traffic white, silk matt,
 RAL 9016

Stainless steel handle HB 38-2 on steel infill,
 3 rectangular glazings with clear all-round stripe
 and stainless steel frame: triple-pane insulated
 glass, exterior laminated safety glass, centre
 sand-blasted float, interior clear single-pane safety
 glass, U_D -value up to approx. $0.99 \text{ W}/(\text{m}^2 \cdot \text{K})^*$

Side element / transom light

Triple-pane insulated glazing, exterior laminated
 safety glass, centre float, interior laminated
 safety glass

* Dependent on door size. Specified values for RAM 1230 x 2180 mm.



For a welcoming reception at home



Style 850

Shown: Decograin Golden Oak
Stainless steel handle HB 38-2 on steel infill,
with rounded glazing: triple-pane insulated glass,
exterior laminated safety glass, centre sand-
blasted float with clear stripes, interior clear
laminated safety glass, U_D -value up to
approx. $0.96 \text{ W}/(\text{m}^2 \cdot \text{K})^*$

Side element / transom light

Triple-pane insulated glazing, exterior laminated
safety glass, centre float, interior laminated
safety glass



Style 900

Shown: standard colour Traffic white, silk matt,
RAL 9016
Stainless steel handle HB 38-2 on steel infill,
with rounded glazing: triple-pane insulated glass,
exterior laminated safety glass, centre sand-
blasted float with clear stripes, interior clear
single-pane safety glass, U_D -value up to
approx. $0.96 \text{ W}/(\text{m}^2 \cdot \text{K})^*$

Side element / transom light

Triple-pane insulated glazing, exterior laminated
safety glass, centre float, interior laminated
safety glass

◀ Style 900 in Decograin Titan Metallic CH 703, with side element

* Dependent on door size. Specified values for RAM 1230 x 2180 mm.



Style 600 ■ NEW from summer 2017

Shown: Decograin Winchester Oak
 Stainless steel handle HB 38-2 on steel infill,
 with surface-mounted glazing: triple insulated
 glass, exterior laminated safety glass, centre
 sand-blasted float, interior clear single-pane
 safety glass, U_D -value up to approx.
 $1,0 \text{ W}/(\text{m}^2 \cdot \text{K})^*$

Side element / transom light

Triple-pane insulated glazing, exterior laminated
 safety glass, centre float, interior laminated
 safety glass



Style 015

Shown: Decograin Titan Metallic CH 703
 with embellishments in stainless steel look
 Stainless steel handle HB 14-2 on steel infill,
 optionally with embellishments in stainless steel
 look, U_D -value up to approx. $0.87 \text{ W}/(\text{m}^2 \cdot \text{K})^*$

Side element / transom light

Triple-pane insulated glazing, exterior laminated
 safety glass, centre float, interior laminated
 safety glass



Style 515

Shown: standard colour Traffic white, silk matt, RAL 9016

Stainless steel handle HB 14-2 on steel infill, ribbed, U_D -value up to approx. $0.87 \text{ W}/(\text{m}^2\cdot\text{K})^*$

Side element / transom light

Triple-pane insulated glazing, exterior laminated safety glass, centre float, interior laminated safety glass



Style 010

Shown: Decograin Dark Oak

Stainless steel handle HB 14-2 on steel infill,
Optionally with stainless steel embellishments
(see on right or page 39),

U_D -value up to approx. $0.87 \text{ W}/(\text{m}^2 \cdot \text{K})^*$

Side element / transom light

Triple-pane insulated glazing, exterior laminated
safety glass, centre float, interior laminated
safety glass

Create a stylish entrance area



Style 010, view 460 ■ NEW

Shown: standard colour Traffic white, silk matt, RAL 9016, with stainless steel view 460
Stainless steel handle HB 14-2 on steel infill, ribbed, U_D -value up to approx. $0.87 \text{ W}/(\text{m}^2\cdot\text{K})^*$

Side element / transom light

Triple-pane insulated glazing, exterior laminated safety glass, centre float, interior laminated safety glass



Style 010, view 461 ■ NEW

Shown: standard colour Traffic white, silk matt, RAL 9016, with stainless steel view 461
Stainless steel handle HB 14-2 on steel infill, ribbed, U_D -value up to approx. $0.87 \text{ W}/(\text{m}^2\cdot\text{K})^*$

Side element / transom light

Triple-pane insulated glazing, exterior laminated safety glass, centre float, interior laminated safety glass

Classical charm for the entrance to your home



Style 100

Shown: preferred colour Moss green RAL 6005
Stainless steel handle HB 14-2 on steel infill, with
6 panels, U_D -value up to approx. $0.87 \text{ W}/(\text{m}^2\cdot\text{K})^*$

Side element / transom light

Triple-pane insulated glazing, exterior laminated
safety glass, centre float, interior laminated
safety glass



Style 410

Shown: standard colour Traffic white, silk matt,
RAL 9016

Stainless steel handle HB 14-2 on steel infill,
triple-pane insulated glass, exterior laminated
safety glass, centre sand-blasted float, interior
clear laminated safety glass, U_D -value up to
approx. $1.0 \text{ W}/(\text{m}^2\cdot\text{K})^*$

Side element / transom light

Triple-pane insulated glazing, exterior laminated
safety glass, centre sand-blasted float, interior
laminated safety glass



Style 430

Shown: standard colour Traffic white, silk matt, RAL 9016

Stainless steel handle HB 14-2 on steel infill, triple-pane insulated glass, exterior laminated safety glass, centre sand-blasted float with clear stripes, interior clear laminated safety glass, U_D -value up to approx. $1.0 \text{ W}/(\text{m}^2 \cdot \text{K})^*$

Side element / transom light

Triple-pane insulated glazing, exterior laminated safety glass, centre sand-blasted float, interior laminated safety glass



Style 450

Shown: standard colour Traffic white, silk matt, RAL 9016

Stainless steel handle HB 14-2 on steel infill, triple-pane insulated glass, exterior laminated safety glass, centre sand-blasted float with clear stripes, interior clear laminated safety glass, U_D -value up to approx. $1.0 \text{ W}/(\text{m}^2 \cdot \text{K})^*$

Side element / transom light

Triple-pane insulated glazing, exterior laminated safety glass, centre sand-blasted float, interior laminated safety glass



Turn your entrance into an eye-catcher

The Thermo46 doors offer you everything that makes for an excellent entrance door. With a U_D -value up to approx. $1.1 \text{ W}/(\text{m}^2 \cdot \text{K})$, the Thermo46 door achieves excellent thermal insulation values. Thanks to the standard 5-point security lock, the entrance doors are ideally equipped when it comes to security. Some styles are optionally available with RC 2 safety equipment to make you feel even more secure in your own four walls.

Choose your favourite from 13 door styles – from modern to classic. You can customise your Hörmann door with colours, glazings, side elements and transom lights according to your preferences.

**Style 700**

Shown: Decograin Titan Metallic CH 703

Stainless steel handle HB 38-2 on steel infill,
full glazing: triple-pane insulated glass, exterior
laminated safety glass, centre sand-blasted float
with clear stripes, interior clear single-pane safety
glass, U_D -value up to approx. $1.3 \text{ W}/(\text{m}^2 \cdot \text{K})^*$

Side element / transom light

Double-pane insulated glazing, exterior laminated
safety glass, interior laminated safety glass,
sand-blasted float

A simple way to show good taste



Style 750

Shown: standard colour Traffic white, silk matt, RAL 9016

Stainless steel handle HB 38-2 on steel infill, full glazing: triple-pane insulated glass, exterior laminated safety glass, centre sand-blasted float with clear stripes, interior clear single-pane safety glass, U_D -value up to approx. $1.2 \text{ W}/(\text{m}^2 \cdot \text{K})^*$

Side element / transom light

Double-pane insulated glazing, exterior laminated safety glass, interior laminated safety glass, float



Style 900

Shown: Decograin Golden Oak

Stainless steel handle HB 38-2 on steel infill, with rounded glazing: triple-pane insulated glass, exterior laminated safety glass, centre sandblasted float with clear stripes, interior clear single-pane safety glass, U_D -value up to approx. $1.2 \text{ W}/(\text{m}^2 \cdot \text{K})^*$

Side element / transom light

Double-pane insulated glazing, exterior laminated safety glass, interior laminated safety glass, float

Timeless elegance for your home



Style 010

Shown: preferred colour Anthracite grey RAL 7016
Stainless steel handle HB 14-2 on steel infill,
 U_D -value up to approx. $1.1 \text{ W}/(\text{m}^2\cdot\text{K})^*$

Side element / transom light

Double-pane insulated glazing, exterior laminated safety glass, interior single-pane safety glass



Style 020

Shown: standard colour Traffic white, silk matt, RAL 9016

Stainless steel handle HB 14-2 on steel infill, full glazing: double-pane insulated glass, exterior laminated safety glass, interior single-pane safety glass, Mastercarré, U_D -value up to approx. $1.4 \text{ W}/(\text{m}^2\cdot\text{K})^*$

Side element / transom light

Double-pane insulated glazing, exterior laminated safety glass, interior single-pane safety glass, Mastercarré



Style 030

Shown: preferred colour Window grey RAL 7040
 Stainless steel handle HB 14-2 on steel infill,
 full glazing: double-pane insulated glass,
 exterior laminated safety glass, interior single-
 pane safety glass, Mastercarré, U_D-value
 up to approx. 1.3 W/(m²·K)*

Side element / transom light

Double-pane insulated glazing, exterior laminated
 safety glass, interior single-pane safety glass,
 Mastercarré



Style 040

Shown: standard colour Traffic white, silk matt,
 RAL 9016
 Stainless steel handle HB 14-2 on steel infill, with
 round glazing Ø 300 mm: double-pane insulated
 glass, exterior laminated safety glass, interior
 single-pane safety glass, ornamental glass 504,
 U_D-value up to approx. 1.2 W/(m²·K)*

Side element / transom light

Double-pane insulated glazing, exterior laminated
 safety glass, interior single-pane safety glass,
 ornamental glass 504

* Dependent on door size. Specified values for RAM 1230 x 2180 mm.



Style 515

Shown: Decograin Titan Metallic CH 703
with embellishments in stainless steel look
Stainless steel handle HB 14-2 on steel infill,
ribbed, U_D -value up to approx. $1.1 \text{ W}/(\text{m}^2 \cdot \text{K})^*$

Side element / transom light

Double-pane insulated glazing, exterior laminated
safety glass, interior laminated safety glass, clear

With embellishments in stainless steel look



Style 015

Shown: standard colour Traffic white, silk matt, RAL 9016

Stainless steel handle HB 14-2 on steel infill, ribbed, optionally with embellishments in stainless steel look, U_D -value up to approx. $1.1 \text{ W}/(\text{m}^2 \cdot \text{K})^*$

Side element / transom light

Double-pane insulated glazing, exterior laminated safety glass, interior laminated safety glass, clear



Style 025

Shown: standard colour Traffic white, silk matt, RAL 9016 with embellishments in stainless steel look

Stainless steel handle HB 14-2 on steel infill, optionally with embellishments in stainless steel look, full glazing: double-pane insulated glass, exterior laminated safety glass, interior single-pane safety glass, Mastercarré, U_D -value up to approx. $1.4 \text{ W}/(\text{m}^2 \cdot \text{K})^*$

Side element / transom light

Double-pane insulated glazing, exterior laminated safety glass, interior single-pane safety glass, Mastercarré



Style 100

Shown: standard colour Traffic white, silk matt,
RAL 9016

Stainless steel handle HB 14-2 on steel infill, with
6 panels, U_D -value up to approx. $1.1 \text{ W}/(\text{m}^2\cdot\text{K})^*$

Side element with panel infill

3 panels

Side element / transom light

Double-pane insulated glass, exterior laminated
safety glass, interior single-pane safety glass,
cathedral glass with small hammered finish

For fans of the country style



Style 200

Shown: standard colour Traffic white, silk matt, RAL 9016

Stainless steel handle HB 14-2 on steel infill, double-pane insulated glass, exterior laminated safety glass, interior single-pane safety glass, cathedral glass with small hammered finish with surface-mounted rails, U_D -value up to approx. $1.2 \text{ W}/(\text{m}^2\cdot\text{K})^*$

Side element with panel infill

3 panels

Side element / transom light

Double-pane insulated glass, exterior laminated safety glass, interior single-pane safety glass, cathedral glass with small hammered finish



Style 400

Shown: standard colour Traffic white, silk matt, RAL 9016

Stainless steel handle HB 14-2 on steel infill, double-pane insulated glass, exterior laminated safety glass, interior single-pane safety glass, cathedral glass with small hammered finish with surface-mounted rails, U_D -value up to approx. $1.5 \text{ W}/(\text{m}^2\cdot\text{K})^*$

Side element with panel infill

1 panel and double-pane insulated glass, exterior laminated safety glass, interior single-pane safety glass, cathedral glass with small hammered finish

Side element / transom light

Double-pane insulated glass, exterior laminated safety glass, interior single-pane safety glass, cathedral glass with small hammered finish

* Dependent on door size. Specified values for RAM 1230 x 2180 mm.

Reassuring security



5-point security lock

You will feel safe at home: 2 conical swing bolts **4** engage with 2 additional security bolts **3** and 1 lock bolt **2** in the frame's lock plates and pull the door tightly shut. The lock plates on Thermo65 doors are adjustable for an optimal door setting. Thanks to the soft-lock latch **1**, the door closes very quietly.



Securing the hinge side

Being able to rest easy in your own home is important, which is why your Thermo46 / Thermo65 door is secured additionally on the hinge side, making it practically impossible to force the door open.

5 Thermo46

With 3 security bolts

6 Thermo65

With continuous safety device strip made of aluminium

7 Perfectly hung with 3-way adjustable guide rollers

Sturdy, two-part 3-way adjustable hinges with safety pins and stainless steel decorative covers guarantee smooth door function.

8 Interior lever

Each door comes with a beautifully shaped stainless steel interior lever as standard.

9 Exterior rose escutcheon

Thermo65 and Thermo46 doors come as standard with a stainless steel exterior rose escutcheon. The security sliding rose escutcheon for Thermo65 doors makes it more difficult to manipulate the locking cylinder, making it ideally equipped in terms of security.

10 Profile cylinder

Delivered with 5 keys as standard. With emergency and hazard function, i.e. the door lock can still be operated when the key is inserted on the inside.

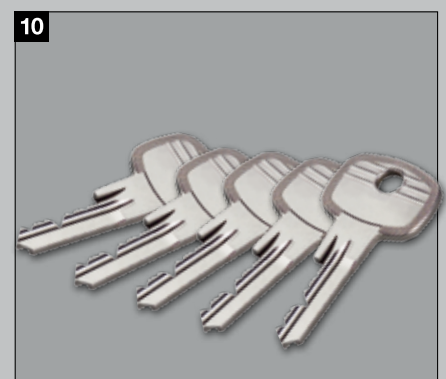

Custom equipment

Open your door easily and conveniently via multiple-point locking using a hand transmitter, radio finger-scan or transponder. There's no longer any danger of forgetting your keys.

1 Opening via a radio finger-scan or a hand transmitter

When operating the entrance door via a radio finger-scan or hand transmitter, it automatically unlocks via an electric motor. You can then push the door open.

Electric strike (not shown)

With the electric strike catch, you can conveniently open your door via a switch inside the house. Alternatively, e.g. during the day, you can also toggle the locking lever so that the entrance door can be opened by a slight push from the outside.

Door drip (not shown)

Attractive protection: The door drip in Traffic white RAL 9016 diverts driving rain and is easy to retrofit.



Standard hand transmitter HSE 4 BS black textured surface with black plastic caps

The options below are for the Thermo46 styles 100, 200 and 400 only:

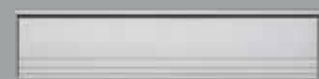

Letter plate
(shown in silver)



Spy Viewer
For doors without windows
(Optional extra)

Glazings for doors



**Thermo65
with triple-pane
insulated glazing
Style 700 / 750 / 800 /
810 / 850 / 900**

**Thermo46
with triple-pane
insulated glazing
Style 700 / 750 / 900**

These styles offer a nearly solid look on the inside and outside. The stainless steel glazing frame complements its elegant overall appearance. Convincing when it comes to saving energy: triple-pane insulated glazings with high thermal insulation values.



**Thermo46
with double-pane
insulated glazing
Style 020 / 025 / 030 / 040**

These doors are equipped with a double-pane insulated glazing, guaranteeing excellent thermal insulation. A modern, harmonious overall door appearance is created with a round-style plastic glazing frame. With Decograin surfaces, the glazing frame is painted in a colour complementing the surface finish.



**Thermo65
with triple-pane
insulated glazing
Style 410 / 430 / 450**

**Thermo46
with double-pane
insulated glazing
Style 200 / 400**

Panelled door styles are a stylish way to present your home with their perfectly matching profile-style plastic glazing frames. When it comes to thermal insulation, the double-pane insulated glazing gives you everything you expect from a high-quality Hörmann entrance door.



**Thermo65
with triple-pane
insulated glazing
Style 600**

The black contrast frame gives the fitted glazing an elegant appearance. Insulated glazing also ensures high thermal insulation, as you would expect in a modern, high-quality entrance door.

Glazings for side elements and transom lights

Thermo46 doors are supplied with side elements and transom lights with double-pane insulated glazing, Thermo65 doors with triple-pane insulated glazing. Please refer to the individual door types for glazing options available.



Sand-blasted
(Thermo65, Thermo46)



Sand-blasted
with clear stripes
(Thermo65, Thermo46)



Clear glass
(Thermo65, Thermo46)

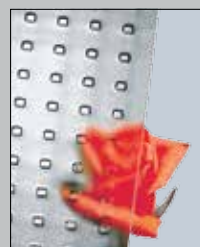

Mastercarré
(Thermo46)

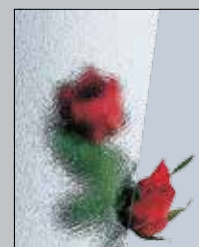

Ornament 504
(Thermo46)



Cathedral small
hammered finish
(Thermo46)

A beautiful handle accents the door: select your desired handle

As standard, all doors come with the exterior handles shown (from page 14). Alternatively, you can select a different handle made of stainless steel.

Exterior handles



Lever handle sets for outside and inside



Stainless steel lever handle set Type D-110 (Standard), also available as lever handle / lever handle



Stainless steel lever handle set Type D-210 ■ NEW



Stainless steel lever handle set Type D-310 ■ NEW



Stainless steel lever handle set Type D-510 ■ NEW



ES 0 / ES 1 lever / knob handle set with knob (shown: ES 1 in stainless steel)



Door handle set ES 0 / ES 1 (shown: ES 0 in stainless steel)

Stainless steel embellishments enhance your entrance

Create your own design on the exterior of style 010 using these attractive stainless steel accents. The embellishments are available for Thermo65 and Thermo46 door versions and for all door colours or decors.



Style 010, view 451 ■ NEW



Style 010, view 454 ■ NEW



Style 010, view 457 ■ NEW



Style 010, view 459 ■ NEW



Style 010, view 460 ■ NEW



Style 010, view 461 ■ NEW

Find your favourite colour

Do you prefer a subtle Window grey or would you like to show your true colours with Ruby red? When choosing a colour for your new Hörmann entrance door, we let your creativity run wild. You can choose between the particularly inexpensive Traffic white RAL 9016 and 16 additional preferred colours*. The interior and exterior of your Thermo65 or Thermo46 doors are always the same colour. Simply contact your Hörmann partner.

In low-cost Traffic white as standard



16 preferred colours*

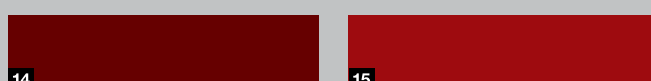

- 1 RAL 9016 Traffic white
- 2 RAL 9007 Grey aluminium
- 3 RAL 9006 White aluminium
- 4 RAL 9002 Grey white
- 5 RAL 9001 Cream
- 6 RAL 8028 Terra brown
- 7 RAL 8003 Clay brown
- 8 RAL 7040 Window grey
- 9 RAL 7035 Light grey
- 10 RAL 7016 Anthracite grey
- 11 RAL 6005 Moss green
- 12 RAL 5014 Pigeon blue
- 13 RAL 5010 Gentian blue
- 14 RAL 3004 Purple red
- 15 RAL 3003 Ruby red
- 16 RAL 3000 Flame red
- 17 RAL 1015 Light ivory

Elegance and detailed accuracy

Decograin** is available in four natural-looking timber designs and one anthracite design with a metallic effect. An embossed wood grain gives it an authentic timber character.

5 Decograin decors**

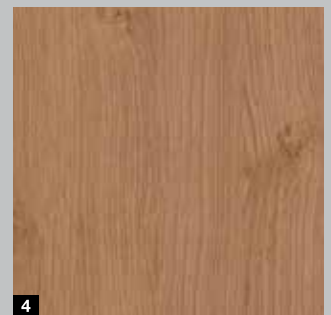
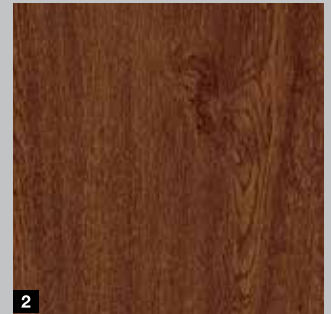
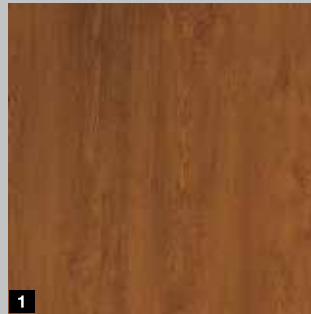

- 1 Golden Oak: medium brown, golden yellow oak design
- 2 Dark Oak: walnut-coloured oak decor
- 3 Night Oak: dark, intense oak design
- 4 Winchester Oak: natural-coloured knotty oak design
- 5 Titan Metallic CH 703: Anthracite with a metallic effect

Please note:

The colours and surface finishes shown are subject to the limitations of the printing process and cannot be regarded as binding. Dark colours should not be used for doors that are exposed to the sun, as an increased material expansion may impair the door's function.

* Not available for Thermo65 styles 410, 430, 450.

**Not available for Thermo65 styles 100, 410, 430, 450 and Thermo46 styles 100, 200, 400. Glazing frames in matching colours for Thermo46 styles 020, 025, 030, 040.

You can customise your entrance area

For Thermo65 and Thermo46 entrance doors, you can order the door leaf and frame in different colours to fit your own individual taste. Combine the standard colour Traffic white RAL 9016, 16 preferred colours or 5 Decograin decors to perfectly match your home and decorating style.

Door leaf and frame in different colours



Frame in White aluminium RAL 9006, door leaf in Grey aluminium RAL 9007



Frame in Titan Metallic CH 703, door leaf in Traffic white RAL 9016



Frame in White aluminium RAL 9006, door leaf in Titan Metallic CH 703



Frame in Anthracite grey RAL 7016, door leaf in Purple red RAL 3004

Entrance doors in harmony with internal doors

Design your Thermo65 entrance door in Decograin Golden Oak, Dark Oak or Titan Metallic CH 703 on the inside to match your white internal doors. All door styles are available with rounded frames in the Decograin decors listed, on the inside in Traffic white RAL 9016 – on request with side elements in the same colour combination. This way, you can enjoy your perfectly matching entrance door and internal doors.

Two-colour entrance doors and side elements



Viewed from outside
in Decograin surface



Viewed from inside
in Traffic white RAL 9016*

Please note:

The colours and surface finishes shown are subject to the limitations of the printing process and cannot be regarded as binding. Dark colours should not be used for doors that are exposed to the sun, as an increased material expansion may impair the door's function.

* Not available for Thermo65 styles 100, 410, 430, 450 and all Thermo46 styles.

Standard sizes Thermo65

Overall frame dimension (ordering size)	Clear passage*
1,000 × 2,100	850 × 2,005
1,100 × 2,100	950 × 2,005

Special sizes Thermo65 / Thermo46

Styles	Overall frame dimension (ordering size)
200	875 – 1,100 × 1,990 – 2,186
010, 020, 030, 040, 700, 750, 800, 810, 900	700 – 1,250 × 1,875 – 2,250
015, 025, 515	875 – 1,250 × 1,875 – 2,250
100, 400, 410, 430, 450	875 – 1,100 × 1,875 – 2,186
850, 900	800 – 1,250 × 1,875 – 2,250

Standard European sizes Thermo46

Overall frame dimension (ordering size)	Clear passage*
1,000 × 2,100	872 × 2,016
1,100 × 2,100	972 × 2,016

Thermo65

Frame variants

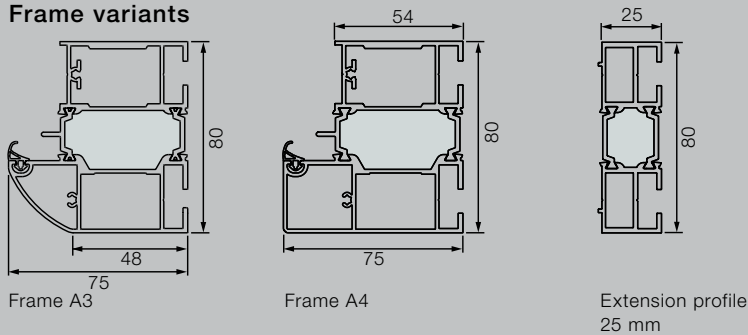

Horizontal view of door

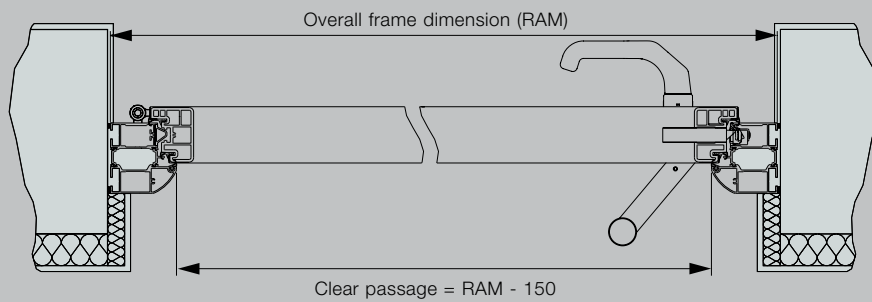

Vertical view of door

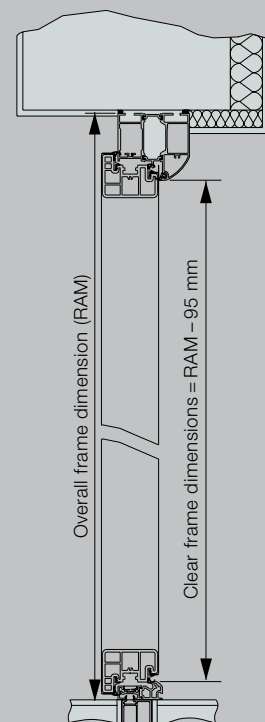

Horizontal view of side element

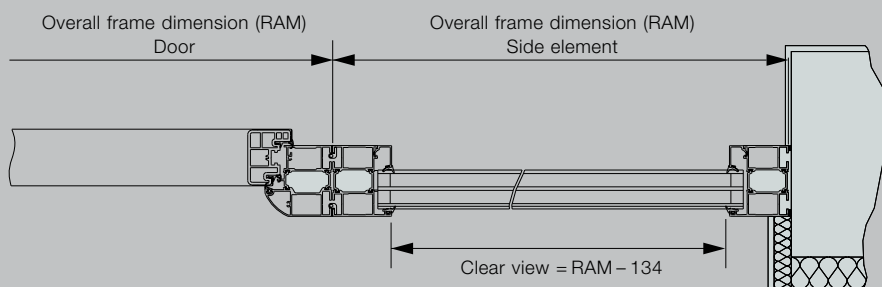

All dimensions in mm

Side element standard sizes
Thermo65 / Thermo46

Styles	Overall frame dimension (ordering size)
Glass infill: 010, 015, 020, 025, 030, 040, 515, 100, 410, 430, 450, 700, 750, 800, 810, 850, 900	400 x 2,100

Transom light special sizes
Thermo65 / Thermo46

Styles	Overall frame dimension (ordering size)
Glass infill: 010, 015, 020, 025, 030, 040, 515, 100, 410, 430, 450, 700, 750, 800, 810, 900	875 – 2,250 x 300 – 500

Side element special sizes
Thermo65 / Thermo46

Styles	Overall frame dimension (ordering size)
Glass infill: 010, 015, 020, 025, 030, 040, 515, 100, 410, 430, 450, 700, 750, 800, 810, 850, 900	Thermo46: 300 – 1,000* x 1,875 – 2,250 Thermo65: 300 – 1,000* x 1,875 – 2,250
Panel infill: 100, 200, 400	450 x 1,990 – 2,186

* Transom light not possible from a width of 500 mm. Door sets with side elements do not contribute to the static equilibrium, which must be guaranteed by the building structure.

Thermo46

Frame variants

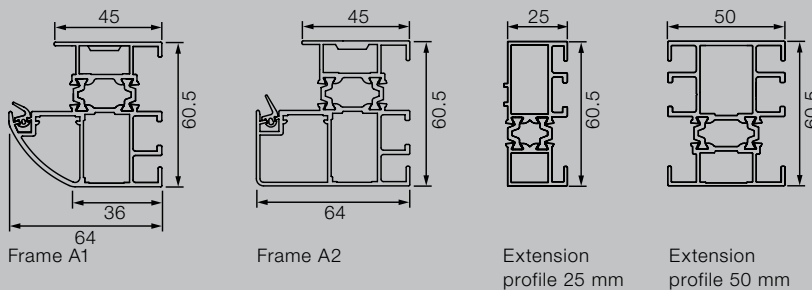

* The clear passage width does not allow for the handle projection on the width.

** The structural opening height is based on the finished floor dimension which includes any and all floor coverings. (Please note that each application/project is unique and the tolerance may alter) These doors are rebated on all four sides, failure to take the floor covering into consideration could prevent the door from opening.

Horizontal view of door

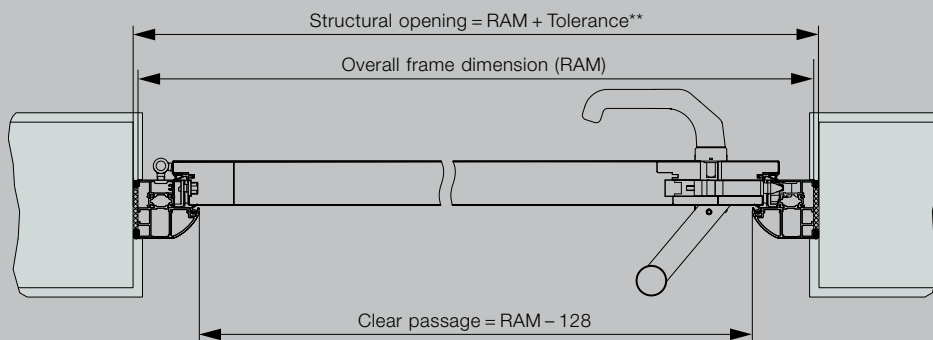

Vertical view of door

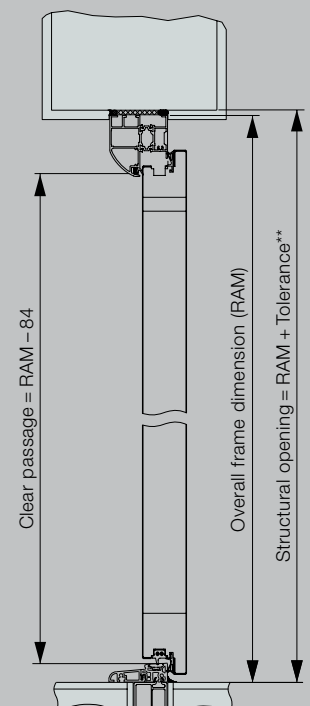

Horizontal view of side element

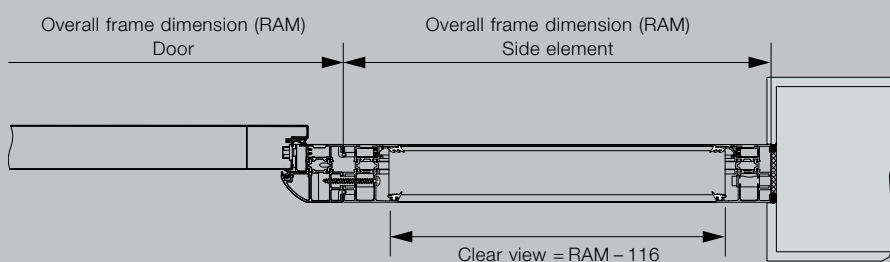

All dimensions in mm



Experience Hörmann quality in new construction and modernisation

Hörmann provides an excellent basis for comprehensive planning. Carefully matched solutions offer you the very best in perfectly designed products for every area.

- **Garage doors**

Optimally match your personal architectural style: up-and-over or sectional doors made of steel or timber.

- **Door operators**

Enjoy extra convenience and break-in-resistant security with Hörmann operators for garage doors and entrance gates. You can profit from the convenience of Hörmann door operators in your residential space as well.

- **Entrance doors**

Our comprehensive entrance door ranges include models that fit almost every need and requirement.

- **Steel doors**

Sturdy doors for your entire home, from basement to roof.

- **Frames**

Choose from our comprehensive range of products for new construction, expansion and modernisation.



Garage doors and entrance gate operators



Thermo46 entrance door



Steel doors

Hörmann: Quality without Compromise



Hörmann KG Amshausen, Germany



Hörmann KG Antriebstechnik, Germany



Hörmann KG Brandis, Germany



Hörmann KG Brockhagen, Germany



Hörmann KG Dissen, Germany



Hörmann KG Eckelhausen, Germany



Hörmann KG Freisen, Germany



Hörmann KG Ichttershausen, Germany



Hörmann KG Werne, Germany



Hörmann Alkmaar B.V., Netherlands



Hörmann Legnica Sp. z o.o., Poland



Hörmann Beijing, China



Hörmann Tianjin, China



Hörmann LLC, Montgomery IL, USA



Hörmann Flexon LLC, Burgettstown PA, USA



Shakti Hörmann Ltd., India

Hörmann is the only manufacturer worldwide that offers you a complete range of all major building products from one source. We manufacture in highly-specialised factories using the latest production technologies. The close-meshed network of sales and service companies throughout Europe, and activities in the USA and Asia, make Hörmann your strong partner for first-class building products, offering "Quality without Compromise".

GARAGE DOORS
OPERATORS
INDUSTRIAL DOORS
LOADING EQUIPMENT
HINGED DOORS
DOOR FRAMES