

Side sliding sectional doors

NEW: Generation 4 garage door operators, now with even faster door opening, whilst offering even more convenience with smart functions

Discover the space you could save

Hörmann side sliding sectional doors are the ideal solution for special fitting situations:

In contrast to up-and-over doors, sectional doors and roller garage doors, this type of door opens to the side instead of upwards. This is particularly advantageous if, for example, the garage ceiling has to remain free to store items (such as surfboards), or the door leaf cannot be stowed underneath or fitted to the ceiling due to construction reasons (a sloped roof, low lintel, obstructive drainpipes).





“A good reputation must be earned.”

August Hörmann

In keeping with the tradition started by the company's founder, the Hörmann brand today is a true promise of quality. The family-owned company has over 80 years of experience in door and operator construction and, with sales of over 20 million doors, is no. 1 in Europe. This makes a Hörmann side sliding sectional door a reassuring purchase.



1 “Made in Germany”

All essential doors and operator components are developed and manufactured by Hörmann, are **perfectly matched to each other** and **tested and certified** by independent, recognised institutes to ensure your safety. They are manufactured in Germany according to the DIN ISO 9001 quality management system and meet the requirements of European standard 13241. Furthermore, our highly qualified employees work intensively on new products, continual further developments and improvements to details. The results are patents and unique products on the market.

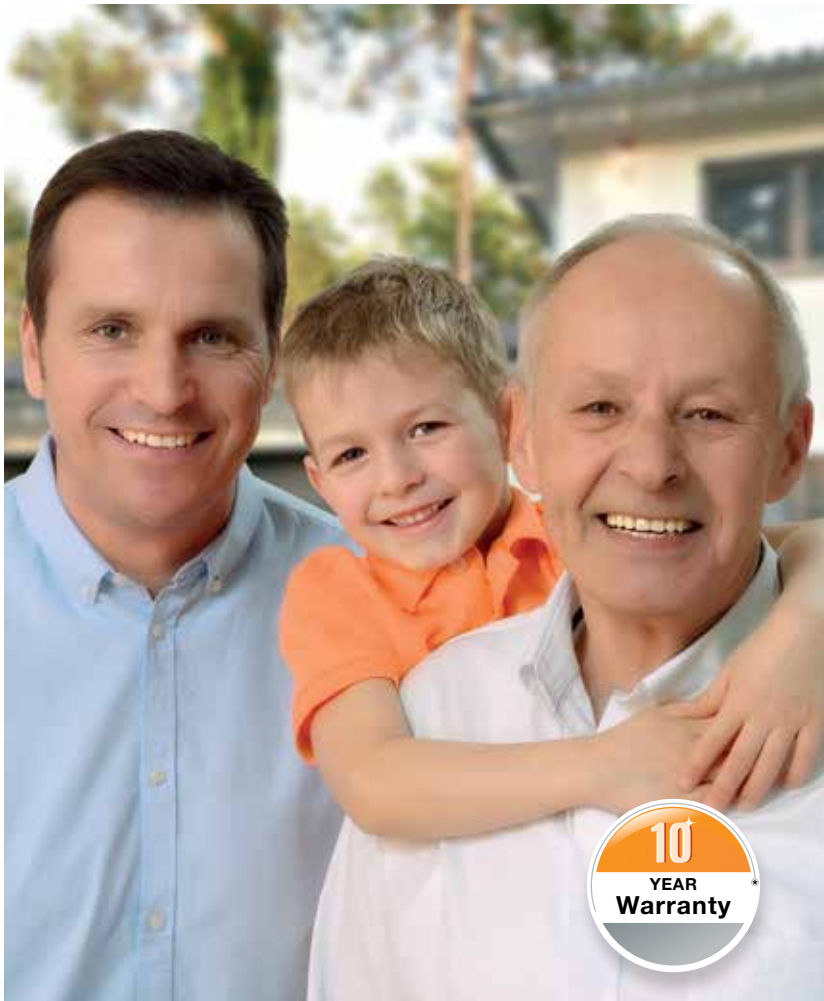

2 Brand quality for generations

Endurance tests under real conditions ensure mature series products with Hörmann quality. Thanks to this, as well as excellent technical solutions and uncompromising quality assurance, you receive a **10-year warranty on all Hörmann sectional doors and a 5-year warranty on Hörmann operators.***

* The complete warranty conditions can be found at: www.hormann.co.uk

3 An eye on the future

Hörmann is setting a good example. This is why the company obtains **100 % of its energy consumption from green sources**. Together with an intelligent and certified energy management system, CO₂-neutral mailing and the recycling of valuable materials, more than **40000 tons of CO₂ are saved each year**. And last but not least, Hörmann also offers products for sustainable construction.



4 Light, quiet, precise

42-mm-thick panels with PU foam infill are guided safely and precisely at the top by **stable twin rollers** and at the bottom in a rounded floor rail. The floor rail is open on both ends, making it easy to clean.

5 Reliable

Optimally shaped door section transitions and hinges **prevent fingers from being accidentally trapped.**

The **reliable automatic safety cut-out** is active **during both the opening and closing cycle of the door.** The door stops immediately if there is an obstacle in the opening area or in the wall guide. This prevents injuries and damage to vehicles or property.

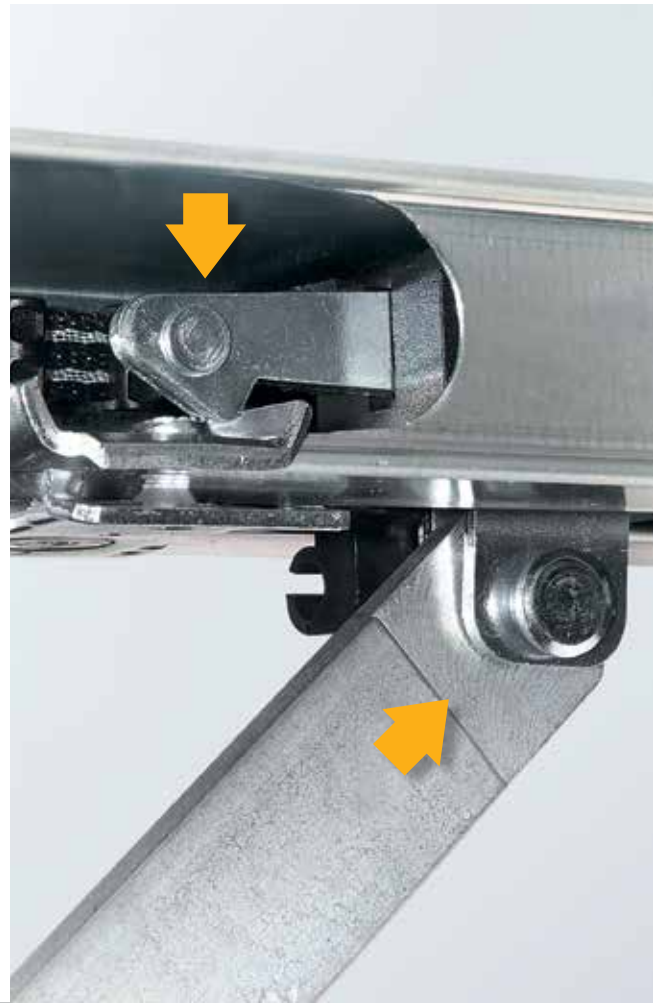

6 Convenient

Side sliding sectional doors can also be opened partially to allow pedestrian passage.

This way you can get into your garage faster, for example if you want to get your bicycle out.



The pedestrian passage can be individually set in doors with an operator. The door is operated via the hand transmitter or the optional door handle with radio module.

For further information, please see page 18.

7 Secure



Uninvited guests barely stand a chance with Hörmann doors with automatic operator. When the garage door is closed, the **anti-lift kit** automatically engages in the guide rail stop, then **locks immediately and is secured against forced opening**. This patented door locking functions purely mechanically and, in contrast to competitor operators, continues to secure the door even when the power fails. Additionally, two hooks on the side of the door connect the end of the door leaf firmly with the side frame.



Watch the video at: www.hormann.co.uk/videos



8 Certified safety

 Only from Hörmann  BiSecur

The bi-directional BiSecur radio system is based on **future-oriented technology** for the convenient and secure operation of garage and entrance gate operators, door operators, lights and more. This extremely secure BiSecur encryption protocol, developed by Hörmann, with a stable, interference-free range makes sure that no one can copy your radio signal. It was tested and certified by security experts at Bochum university and independent test institutes.



Take a look at the video "BiSecur – the radio system with certified safety" at: www.hormann.co.uk/videos

9 Perfectly aligned

All BiSecur operators, receivers and control elements are 100 % compatible. By simply pressing the button on your hand transmitter or radio switch, you can operate your garage door and entrance gate as well as door operators or other devices with BiSecur receivers. The BiSecur control elements are suitable for the operation of all Hörmann operators with a radio frequency of 868 MHz (year of manufacture 2003 – 06/2012) / (querying the door position is not possible). **The standard HCP interface* in every Hörmann operator makes even more possible for you.** It makes it easy to network all Hörmann garage and entrance gate operators with external Smart Home systems.

* HCP = Hörmann Communication Protocol



10 Convenient door query

You no longer have to go out in any wind and weather to check if your door is closed. At the press of a button, the colour of the LED on the hand transmitter HS 5 BS or the internal push button FIT 5 BS indicates the position of the door. If required, another push of a button* closes the door. It is the most convenient and secure way to control your door.

* An additional photocell is required for operation without visual contact to the door.

11 Smart app operation

Hörmann BlueSecur

Simply use your smartphone as a hand transmitter. **With the new Hörmann BlueSecur app, you can conveniently operate your garage door or entrance door via Bluetooth**.** Additional user authorisations*** can easily be permanently or temporarily transferred to the smartphones of your family members. This ensures they always carry their personal “door and gate opener” with them on their smartphone.

** In conjunction with an internal or optional Hörmann Bluetooth receiver

*** Additional purchases (in-app purchases) in the AppStore or Google Play may be required



Display of hand transmitter HS 5 BS

- 1 Door is open
- 2 Door is closed

Side sliding sectional doors HST

The 42-mm-thick, PU-foamed sandwich panels are characterised by excellent acoustic and thermal insulation, in addition to good door leaf stability and quiet operation.



M-ribbed, Traffic white, RAL 9016



L-ribbed, Traffic white RAL 9016

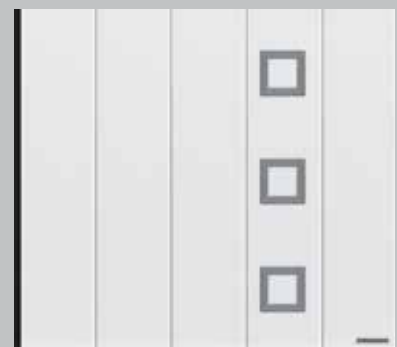

L-ribbed, Traffic white RAL 9016
Style 451 without glazing (not shown)



L-ribbed, Traffic white RAL 9016
Style 461 with glazing

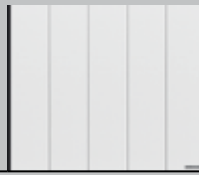

M-ribbed

L-ribbed

Woodgrain	Traffic white RAL 9016 15 preferred colours RAL to choose	Traffic white RAL 9016 15 preferred colours RAL to choose
Sandgrain	Traffic white RAL 9016 3 preferred colours	Traffic white RAL 9016 3 preferred colours
Silkgrain	Traffic white RAL 9016 15 preferred colours RAL to choose	Traffic white RAL 9016 15 preferred colours RAL to choose
Decograin	Golden Oak, Dark Oak, Night Oak, Rosewood, Winchester Oak, Titan Metallic CH 703	Golden Oak, Dark Oak, Night Oak, Rosewood, Winchester Oak, Titan Metallic CH 703
Max. width	6500 mm	6500 mm
Max. height	3000 mm	3000 mm



Performance characteristics according to European standard 13241-1

Thermal insulation

Section	U = 0.5 W/(m ² ·K)
Fitted door*	U = 1.9 W/(m ² ·K)

Sealing

Air	Class 2
Water	Class 2

Wind load	Class 2
-----------	---------

* The U-value applies to fitted doors without glazing with the dimensions: 4200 × 3100 mm

Individual design styles

You can individually position and combine the design elements on your door, as shown in the door views. You can design your own door style. Doors with wicket door are also available with design elements. Your Hörmann partner would be pleased to advise you.



Design element with optional real glass for design styles 461 and 481

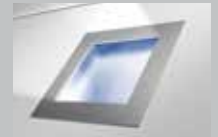

Design element with stainless steel and synthetic glazing



Style 451



Style 461



Style 452



Style 462



Style 471



Style 481



Style 459



Style 469



Style 453



Style 463



Style 455



Style 460



Style 472

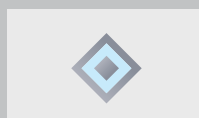

Style 482



Style 473



Style 483



Style 474



Style 475



Style 456

The example styles show doors with the dimensions 2500 × 2125 mm. The following pages illustrate all of the colours, technical data can be found from page 30 onwards.

Steel surface finishes

It's your choice

Design your garage door to exactly fit your needs. You can choose from up to 4 surfaces that you can adapt to match the architecture of your home. Additionally, you can choose from 15 equally-priced preferred colours, approx. 200 RAL colours and 6 Decograin decors. The door surfaces are optimally protected against rust, allowing you to enjoy your new door for a long time. Rain runs off without leaving any streaky marks thanks to the use of hot-galvanized material and a high-quality polyester-primer coating on both sides.

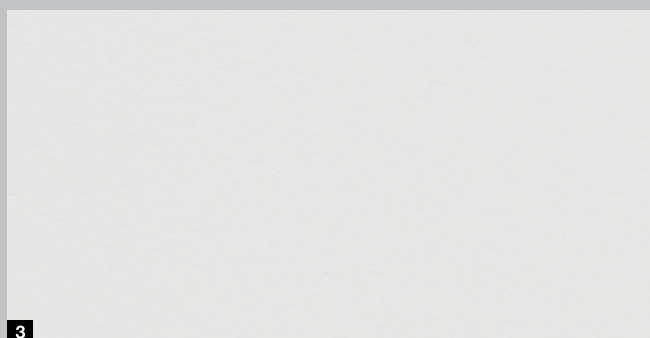

Please note:

Side sliding sectional doors are generally supplied in Grey white, RAL 9002, on the inside of the door.

Dark colours should not be used for double-skinned steel doors that are exposed to the sun, as possible section deflection may restrict the door's function.

All colours are based on RAL. The colours and surfaces shown are subject to the limitations of the printing process and cannot be regarded as binding. Please consult with your Hörmann partner.

Standard colour

1 Woodgrain

On this inexpensive, robust Woodgrain surface with an authentic sawn timber look, minor scratches can be easily repaired by working with the texture.

2 Sandgrain

The finely structured surface is an ideal choice for price-conscious building owners and is particularly suited for modern homes.

3 Silkgrain

Thanks to its elegant door appearance, the silky smooth Silkgrain surface is the first choice for modern architecture.

4 Decograin

The Decograin surface gives your sectional door a striking and authentic timber look or an elegant metallic appearance in Anthracite.



1

15 preferred colours



2



10

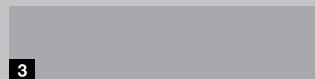

3

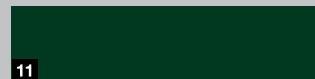

11

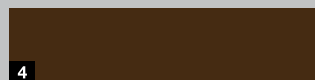

4

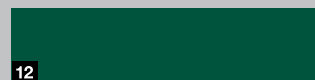

12



5



13

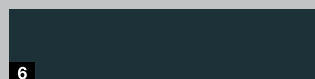

6

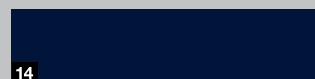

14



7



15

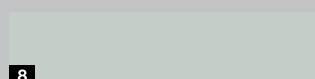

8

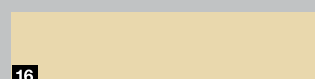

16



9

6 Decograin decors



1



2



3



4



5

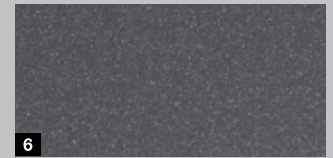

6

1	RAL 9016	Traffic white
2	RAL 9007	Grey aluminium
3	RAL 9006	White aluminium*
4	RAL 8028	Terra brown*
5	RAL 8003	Clay brown
6	RAL 7016	Anthracite grey*
7	RAL 7040	Window grey
8	RAL 7035	Light grey
9	RAL 7030	Stone grey
10	RAL 8001	Ochre brown
11	RAL 6009	Fir green
12	RAL 6005	Moss green
13	RAL 5014	Pigeon blue
14	RAL 5011	Steel blue
15	RAL 3003	Ruby red
16	RAL 1015	Light ivory

1	Decograin Golden Oak: medium brown, golden yellow oak design
2	Decograin Dark Oak: walnut-coloured oak decor
3	Decograin Night Oak: dark, intense oak design
4	Decograin Rosewood: mahogany-coloured timber design
5	Decograin Winchester Oak: natural-coloured knotty oak design
6	Titan Metallic CH 703: Anthracite with a metallic effect

* Preferred colours for Sandgrain surface finish

The elegance of side sliding sectional doors

Create your dream door choosing from seven door styles, ranging from the elegant M- and L-ribbings to exclusive designs with glazings and stainless steel embellishments. Thanks to the wide range of surfaces, colours, and decors, you can perfectly match your side sliding sectional door to the architectural style of your home.





THE ELEGANCE OF SIDE SLIDING SECTIONAL DOORS



▲ L-ribbed, style 461, Hörmann colour CH 703

▶ L-ribbed, Traffic white RAL 9016





◀ M-ribbed, Decograin Golden Oak



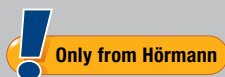

Automatic wicket door function for doors with operators

Using a hand transmitter or the handle on the door, you can partially open your side sliding sectional door to allow pedestrians to pass. A brief actuation of the handle and the door automatically moves into the set position. Actuating the handle again closes the door. You can easily adjust the clear passage width with the operator. For example, a narrow passage for persons or a wider passage for bikes, motorcycles or wheelbarrows.



Integrated lockable handle with full radio internal push button functions

Two buttons and a sliding switch on the interior side of the handle allow you to:

- 1 Completely open and close the door
- 2 Operate the wicket door function
- 3 Switch off the radio signal (away setting)



White aluminium RAL 9006



Traffic white RAL 9016



Brown



Brushed stainless steel



Standard door handle position for M- and L-ribbing



Door handle position for intermediate widths for M- and L-ribbing



Glazing S0



Glazing S1



Glazing S2

4 handle colours

Manually operated doors are supplied as standard with a handle in White aluminium. Three additional colours are optionally available.

The same versions are also available for doors with automatic operator with automatic wicket door function.

3 glazings

The glazings for the top door area are available with a synthetic double pane, either clear or crystal structure. The frames are white as standard and can optionally be delivered in the colour of the door or in RAL to choose.



Ventilation grilles
Ventilation cross section
40 cm² / grille

Ventilation grilles

The ventilation grilles in the bottom part of the door are available in black as standard, and optionally in the colour of the door or in RAL to choose.

Reliable, secure, 100 % compatible

Hörmann garage door operators are perfectly matched to your Hörmann side sliding sectional door. The result: simple operation, maximum convenience and the greatest operational safety.

Using our elegant hand transmitters you can conveniently and safely operate your garage door as well as an entrance gate equipped with a fully compatible Hörmann operator or other devices, such as lamps. It goes without saying that our extensive Hörmann programme offers the right operator and accessories for your wishes and needs.



Garage Door
and Entrance Gate Operators

More information can be found in the "Garage door and entrance gate operators" brochure.





SupraMatic 4

Supra-fast door opening and smart additional functions

- 40 % faster opening speed* up to 20 cm/s
- Smart operation with the BlueSecur app ■ **NEW**
- Convenient garage ventilation
- Up to 3 to 5 times** brighter LED lighting
- Extremely easy programming thanks to 2 x 7-segment display
- High-quality stainless steel operator cover
- Networked with Smart Home systems via the standard HCP interface
- Low power consumption in standby below 1 watt



BiSecur

As standard with two 4-button hand transmitters HSE 4 BS, textured surface black with chrome caps

Garage door operators	SupraMatic E ■ NEW	SupraMatic P ■ NEW
Bluetooth receiver	Integrated, can be switched on and off	Integrated, can be switched on and off
HCP bus connection	Integrated	Integrated
Cycles per day / hour	25 / 10	50 / 10
Pull and push force	650 N	750 N
Peak force	800 N	1000 N
Max. opening speed	20 cm/s	20 cm/s
Lighting	20 LED	30 LED chase light
Max. door width	6000 mm	6500 mm
Max. door surface	13.75 m ²	15 m ²

 **Hörmann BlueSecur**

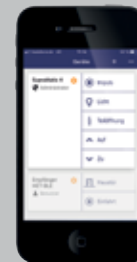

Standard bluetooth receiver for smartphone operation using the Hörmann BlueSecur app

* in comparison with ProMatic series 3

** 3 times brighter with the SupraMatic E or 5 times brighter with the SupraMatic P in comparison to the ProMatic series 3

ProMatic 4

Premium quality at an attractive price

- 20 % faster opening speed*
- Convenient garage ventilation
- Up to 2 times* brighter LED lighting
- Networked with Smart Home systems via the standard HCP interface
- Low power consumption in standby below 1 watt



As standard with two 4-button hand transmitters HSE 4 BS, textured surface black with plastic caps

Garage door operators	ProMatic 4 ■ NEW
Bluetooth receiver	Optional (HET-BLE)
HCP bus connection	Integrated
Cycles per day / hour	25 / 10
Pull and push force	600 N
Peak force	750 N
Max. opening speed	17 cm/s
Lighting	10 LED
Max. door width	5000 mm
Max. door surface	11.25 m ²



1

2

Hand transmitter HS 5 BS

4 button functions, plus query button,

1 High-gloss surface black or white

2 Textured surface black



3

4

5

Hand transmitter HS 4 BS

4 button functions,

3 Textured surface black

Hand transmitter HS 1 BS

1 button function,

4 Textured surface black

Hand transmitter HSE 1 BS

1 button function, including eyelet for key ring

5 Textured surface black



6

7

Hand transmitter HSE 4 BS

4 button functions, including eyelet for key ring

6 Textured surface black with chrome or plastic caps

Hand transmitter HSE 2 BS

2 button functions, including eyelet for key ring

7 High-gloss surface black or white

8 High-gloss surface green, purple, yellow, red, orange

9 Decor in silver, carbon, dark rootwood



8

9

(Shown from left)



10

11

**10 Hand transmitter
HSD 2-A BS**

Aluminium look, 2 button functions, can also be used as a key ring

**11 Hand transmitter
HSD 2-C BS**

High-gloss chrome, 2 button functions, can also be used as a key ring



12

12 Hand transmitter HSP 4 BS

4 button functions, with button lock-out incl. key ring



13

14

13 Hand transmitter HSZ 1 BS

1 button function, for insertion in vehicle cigarette lighter

14 Hand transmitter HSZ 2 BS

2 button functions, for insertion in vehicle cigarette lighter



15

**15 Radio internal push button
FIT 2-1 BS**

For 2 functions, connection option for max. 2 control elements via cable, e.g. key switch



16

**16 Radio code switch
FCT 3 BS ■ NEW**

For 3 functions, with illuminated buttons, recessed and surface-mounted fitting possible



17

**17 Radio code switch
FCT 10 BS ■ NEW**

For 10 functions, with illuminated buttons and hinged cover, recessed and surface-mounted fitting possible



18

**18 Radio finger-scan
FFL 25 BS ■ NEW**

For 2 functions, up to 25 fingerprints, with hinged cover, recessed and surface-mounted fitting possible



19

Key switch

19 STAP 50

20 STUP 50

In a recessed version and surface-mounted version, including 3 keys

Details perfectly matched to each other



The Hörmann side sliding sectional door combines several innovative details – starting with the precise door travel and the secure locking to the special design of the floor rail. Hence this door solution offers you more convenience and security every day.

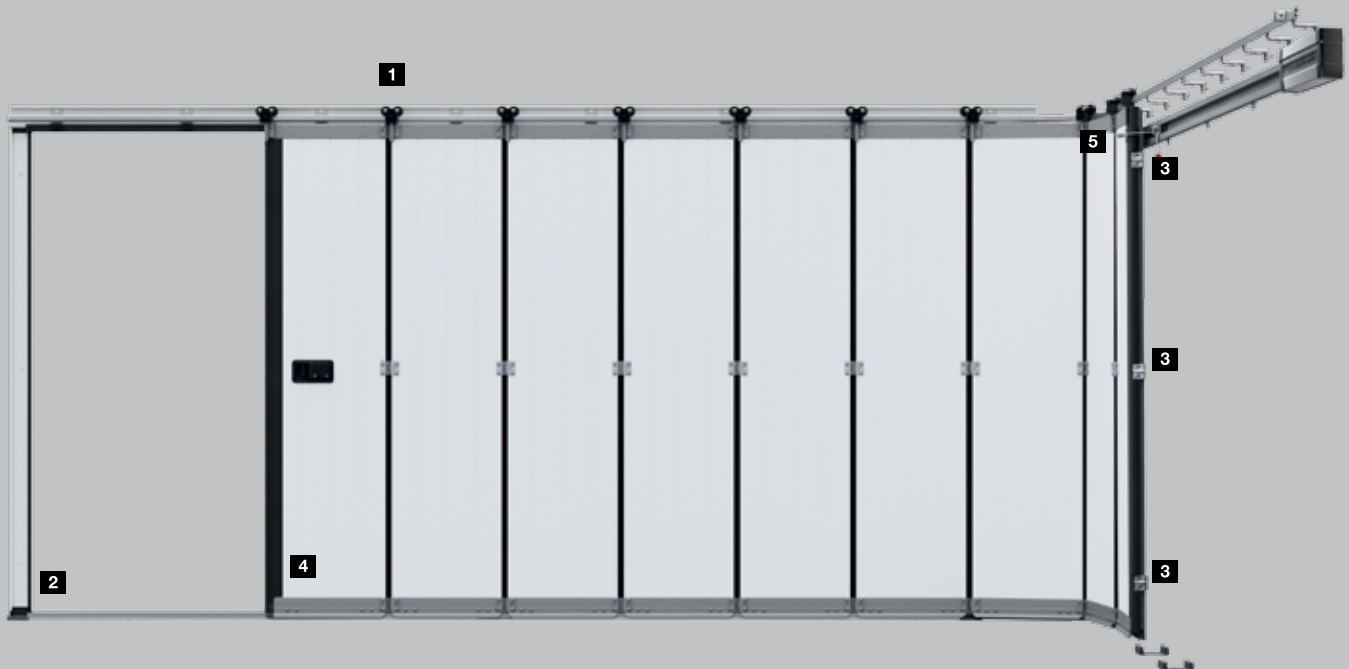

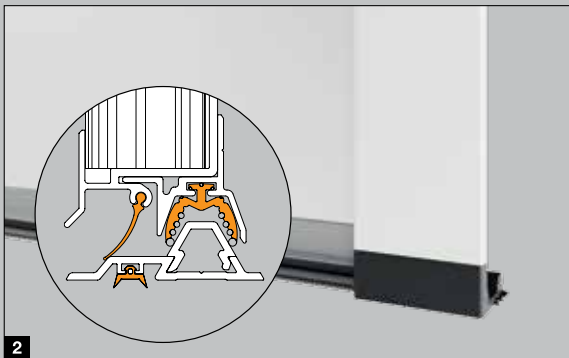

Precise door travel

Twin rollers **1** made of wear-resistant plastic move reliably and precisely on the aluminium rail and prevent the door sections from jumping out. Additionally, they ensure smooth and easy door travel, making it easy to manually open the door. Stable connecting hinges on the rollers and between the PU-foamed 42-mm-thick sections ensure high door leaf stability.

Well-sealed

Thanks to the new floor rail with continuous bottom seal **2** the side sliding sectional door impresses with class 2 water tightness and air permeability. This makes the door well-sealed against rainwater penetration and leaves. This keeps the garage cleaner for longer and means it must be cleaned less often. In addition, the risk of accidents by slipping is reduced.

Securely locked

The bottom and top door guides close the door precisely. Two additional hooks **3** on the sides of the door connect the end of the door leaf tightly to the side frame. In addition, this mechanical lock prevents the door from being forced open.

To improve break-in resistance, manually operated doors can be optionally equipped with 3-point locking at the closing edge.

Well-guided

The bottom aluminium floor rail **4** reliably guides the door sections and prevents the sections from swivelling out. The flat design allows barrier-free access.

Easy fitting

The frame of the side sliding sectional door can be easily screwed together and can subsequently be fastened completely to the garage wall. Fitting in tight spaces with a sideroom of only 140 to 450 mm is made possible with track application DS **5** with double side guides. The side track can be simply fitted with the new adjustable wall brackets.

SIDE DOORS

Garage side doors NT 60

The doors are supplied ready-to-fit with profile cylinder mortice lock, round handle lever handle set with oval rose escutcheons and with 3-way adjustable hinges. Door leaf frames are made of weather-proof aluminium extrusions (depth 60 mm) with all-round seals. Double-leaf side doors are also available with asymmetrical division, i.e. with uneven door leaf widths.

Garage side door NT 60	Single-leaf	Double-leaf
Aluminium block frame	●	●
Aluminium corner frame	●	–
Wide leaf frame	●	●
Thermal insulation	U = 2.7 W/(m ² ·K)	U = 2.9 W/(m ² ·K)

For further information, see page 33 or contact your Hörmann partner.



Single-leaf NT 60 with L-ribbing and wide leaf frame



Double-leaf NT 60 with M-ribbing and wide leaf frame



1 Lever handle set

Choose between the standard lever handle or many optional lever handle or lever / knob handle sets (Fig. Stainless steel lever handle set). Your Hörmann partner would be pleased to advise you.



2 Concealed hinges

For an elegant door view of the single-leaf side doors with aluminium block frame concealed hinges are optionally available.



3 Fixed bolt

The fixed leaf on double-leaf side doors can be individually locked.



4 Matching

Side doors Decograin come with identical surface finishing for the frame, subframe and door to create a matching appearance. The inside of the sections is Grey white, RAL 9002, as standard.



Multi-purpose door MZ Thermo

If you value good thermal insulation and also want to reduce the risk of condensation forming on the inside, an MZ Thermo external door with thermal break is the best choice for you.

It has an excellent thermal insulation value of $1.2 \text{ W}/(\text{m}^2 \cdot \text{K})$. An RC 2 version is optionally available (KSI Thermo).



For further information, see the "Steel doors" brochure.

Determining the operator boom (track applications ES and DS)

Door width (LZ)	Operator boom	Distance back (overall length of operator SupraMatic / ProMatic)
≤ 2205	K	3200
≤ 2375	M	3450
≤ 3000	L	4125
≤ 3275	XL	4375
≤ 4750	5500	5725
≤ 6500	7000	7225

The distance back (overall length of operator) can be shortened on-site up to LZ + 1100 mm.

The side guide can be set back up to 125 mm if the distance back (overall length of operator) is smaller than LZ + 1100 mm.

Explanations

RM	Grid height (ordering size)
LZ	Clear frame dimensions (ordering size)
LDH	Clear passage height
LDB	Clear passage width
ET	Distance back (overall length with operator)
OFF	Finished floor level
ASS	Closing side sideroom
AKS	Curve side sideroom

For more detailed information, please see the technical manual or contact your Hörmann partner.

Track application DS (double track, operator wall fitting)

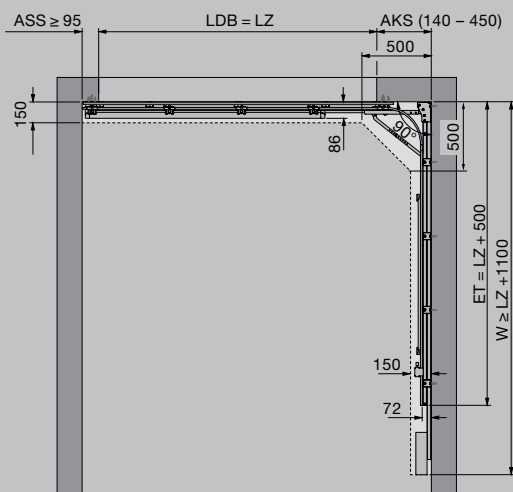

Track application ES (single track, operator ceiling fitting B)

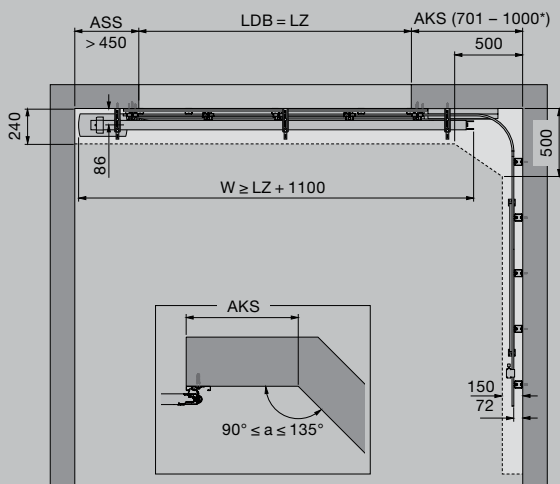

DIMENSIONS AND FITTING DATA

Vertical views

Ceiling fitting B as a sliding door

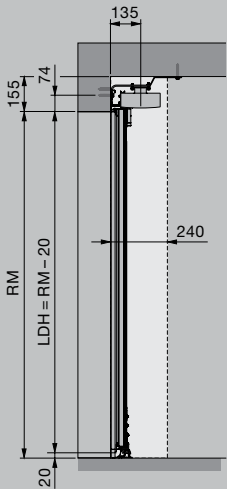

Wall fitting as a sliding door

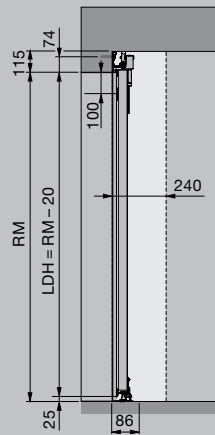

Horizontal views

Ceiling fitting B as a sliding door (floor rail view)

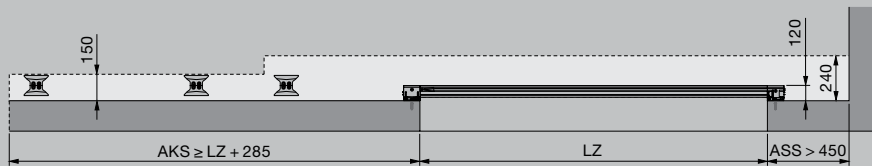

Wall fitting as a sliding door (floor rail view)

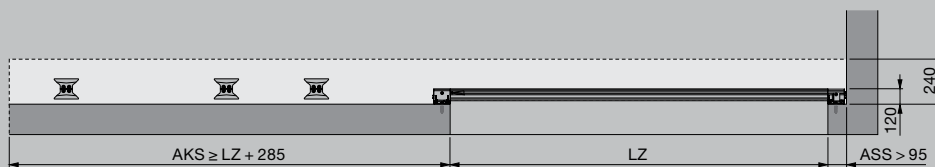

Explanations

- RM Grid height (ordering size)
- LZ Clear frame dimensions (ordering size)
- LDH Clear passage height
- LDB Clear passage width
- ET Distance back (overall length with operator)
- OFF Finished floor level
- ASS Closing side sideroom
- AKS Curve side sideroom

For more detailed information, please see the technical manual or contact your Hörmann partner.

SIZES AND FITTING DATA FOR SIDE DOORS

Horizontal views

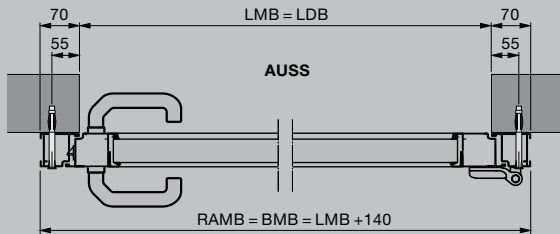

Side door with aluminium block frame
Fitting behind the opening

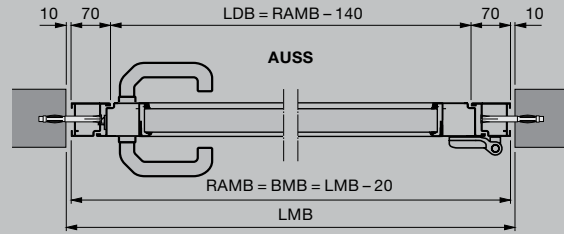

Side door with aluminium block frame
Fitting in the opening

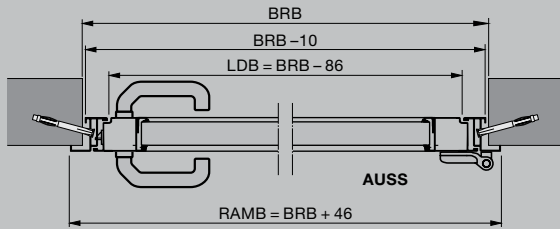

Side door with corner frame
Fitting in front of the opening

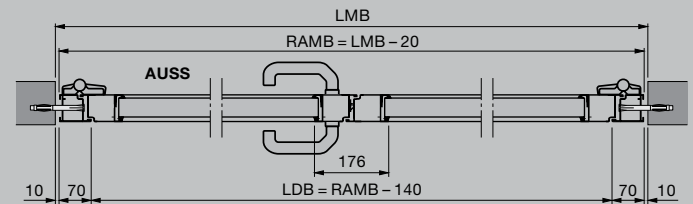

Double-leaf side door with aluminium block frame
Fitting in the opening

Vertical views

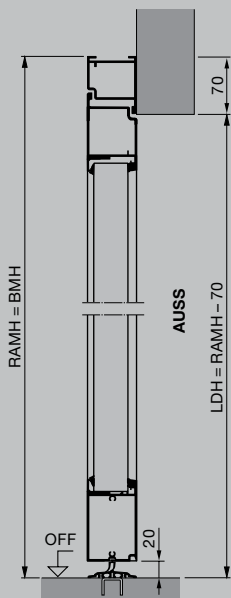

Side door with aluminium block frame
Fitting behind the opening

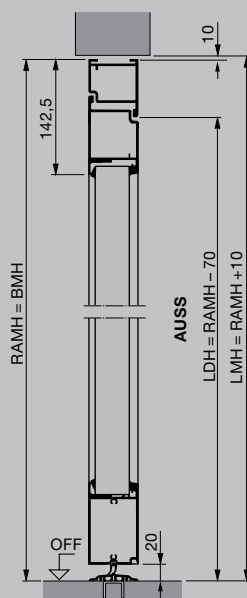

Side door with aluminium block frame
Fitting in the opening

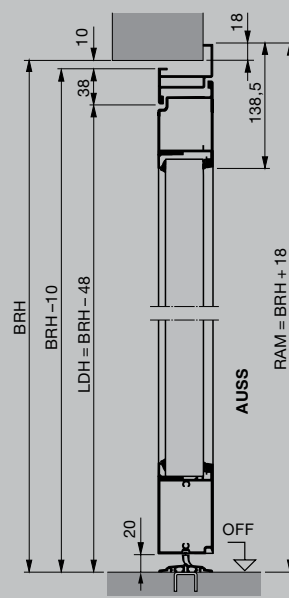

Side door with aluminium corner frame
External fitting

Ordering size = RAM	Lever height DrH	Min. BRB window type S
Corner frame		
Internal fitting opening inwards		
928 - 1284 x 1800 - 2500	1050	525
External fitting opening outwards		
928 - 1284 x 1800 - 2500	1050	525
Block frame		
936 - 1330 x 1800 - 2500	1050	525

- Double-leaf side door with asymmetrical division
- Double-leaf side door opening inwards and outwards



Experience Hörmann quality in new construction and modernisation

Hörmann provides an excellent basis for comprehensive planning. Carefully matched solutions offer you the very best in perfectly designed products for every area.

- **Garage doors**

Optimally match your personal architectural style: up-and-over or sectional doors made of steel or timber.

- **Gate and Door Operators**

Enjoy extra convenience and break-in-resistant security with Hörmann operators for garage doors and entrance gates. You can profit from the convenience of Hörmann door operators in your residential space as well.

- **Entrance doors**

Our comprehensive entrance door ranges include models that fit almost every need and requirement.

- **Steel doors**

Sturdy doors for your entire home, from basement to roof.

- **Frames**

Choose from our comprehensive range of products for new construction, expansion and modernisation.



Garage doors and entrance gate operators



Thermo65 / Thermo46 entrance doors



Steel doors

Hörmann: Quality without Compromise



Hörmann KG Amshausen, Germany



Hörmann KG Antriebstechnik, Germany



Hörmann KG Brandis, Germany



Hörmann KG Brockhagen, Germany



Hörmann KG Dissen, Germany



Hörmann KG Eckelhausen, Germany



Hörmann KG Freisen, Germany



Hörmann KG Ichttershausen, Germany



Hörmann KG Werne, Germany



Hörmann Alkmaar B.V., Netherlands



Hörmann Legnica Sp. z o.o., Poland



Hörmann Beijing, China



Hörmann Tianjin, China



Hörmann LLC, Montgomery IL, USA



Hörmann Flexon LLC, Burgettstown PA, USA



Shakti Hörmann Pvt. Ltd., India

Hörmann is the only manufacturer worldwide that offers you a complete range of all major building products from one source. We manufacture in highly-specialised factories using the latest production technologies. The close-meshed network of sales and service companies throughout Europe, and activities in the USA and Asia, make Hörmann your strong partner for first-class building products, offering "Quality without Compromise".

GARAGE DOORS
OPERATORS
INDUSTRIAL DOORS
LOADING EQUIPMENT
HINGED DOORS
DOOR FRAMES