



Side sliding sectional door

NEW: More design possibilities with 6 Decograin decors

HÖRMANN

Discover the space you could save

Hörmann side sliding sectional doors are the ideal solution for special fitting situations:

In contrast to up-and-over doors, sectional doors and roller garage doors, this type of door opens to the side instead of upwards. This is particularly advantageous if, for example, the garage ceiling has to remain free to store items (such as surfboards), or the door leaf cannot be stowed underneath or fitted to the ceiling due to construction reasons (a sloped roof, low lintel, obstructive drainpipes).





“A good reputation must be earned.”

August Hörmann

In line with the founder's philosophy, the Hörmann brand today is a true promise of quality. The family-owned company has over 80 years of experience in door and operator construction and, with sales of over 20 million doors, is no. 1 in Europe. This makes a Hörmann side sliding sectional door a reassuring purchase.



1 Brand quality “Made in Germany”

All doors and operator components are developed and manufactured by Hörmann, **perfectly matched to each other** and **tested and certified** by independent, recognised institutes to ensure your safety. They are manufactured in Germany according to the DIN ISO 9001 quality management system and meet the requirements of European standard 13241-1. Furthermore, our highly qualified employees work intensively on new products, continual further developments and improvements to details. The results are patents and one-of-a-kind products you can depend on.

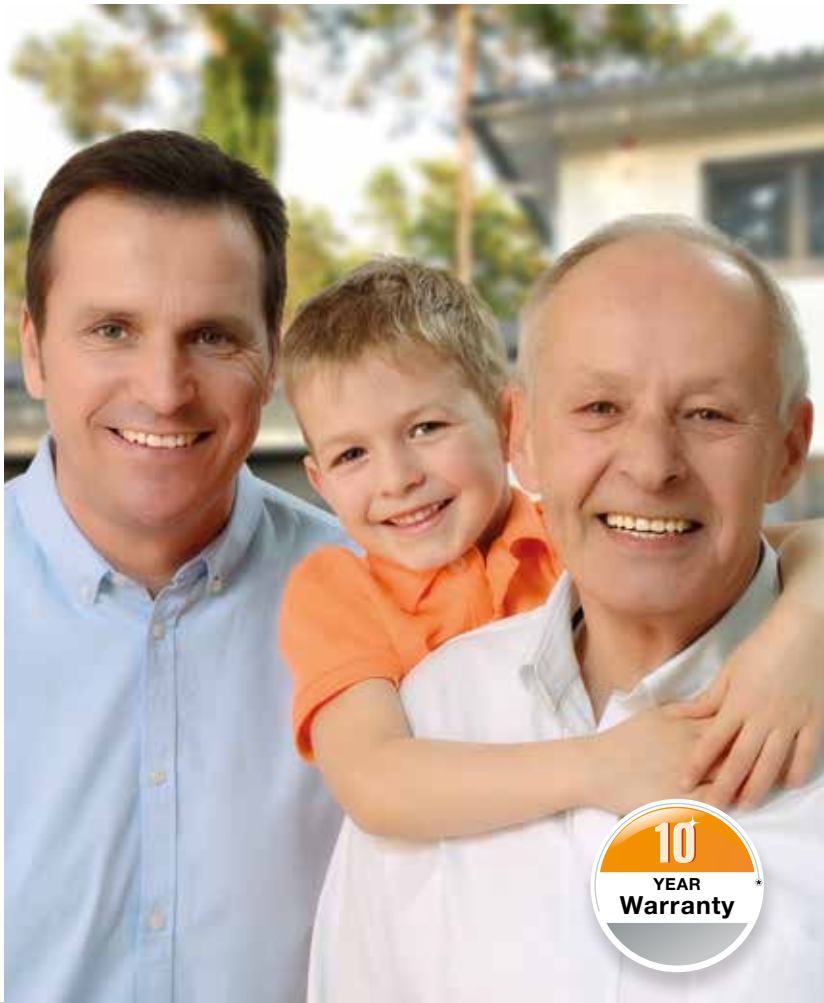

2 Garage doors for generations

Endurance tests under real conditions ensure mature series products with Hörmann quality. Thanks to this, as well as excellent technical solutions and uncompromising quality assurance, you receive a **10-year warranty on all Hörmann side sliding sectional doors and a 5-year warranty on Hörmann operators.***

* The complete warranty conditions can be found at:
www.hoermann.com

3 An eye on the future

Hörmann is setting a good example. This is why the company obtains **100 % of its required energy from green sources.** At the same time, many tonnes of CO₂ are saved each year thanks to the introduction of an intelligent and certified energy management system. And last but not least, Hörmann also offers products for sustainable construction.



4 Light, quiet, precise

42-mm-thick panels with PU foam infill are guided safely and precisely at the top by **stable twin rollers** and at the bottom in a rounded floor rail. The floor rail is open on both ends, making it easy to clean.

5 Reliable

Optimally shaped door section transitions and hinges **prevent fingers from being accidentally trapped**.

The **reliable automatic safety cut-out** is active **during both the opening and the closing cycle of the door**. The door stops immediately if there is an obstacle in the opening zone or in the wall guide. This prevents injuries and damage to vehicles or property.

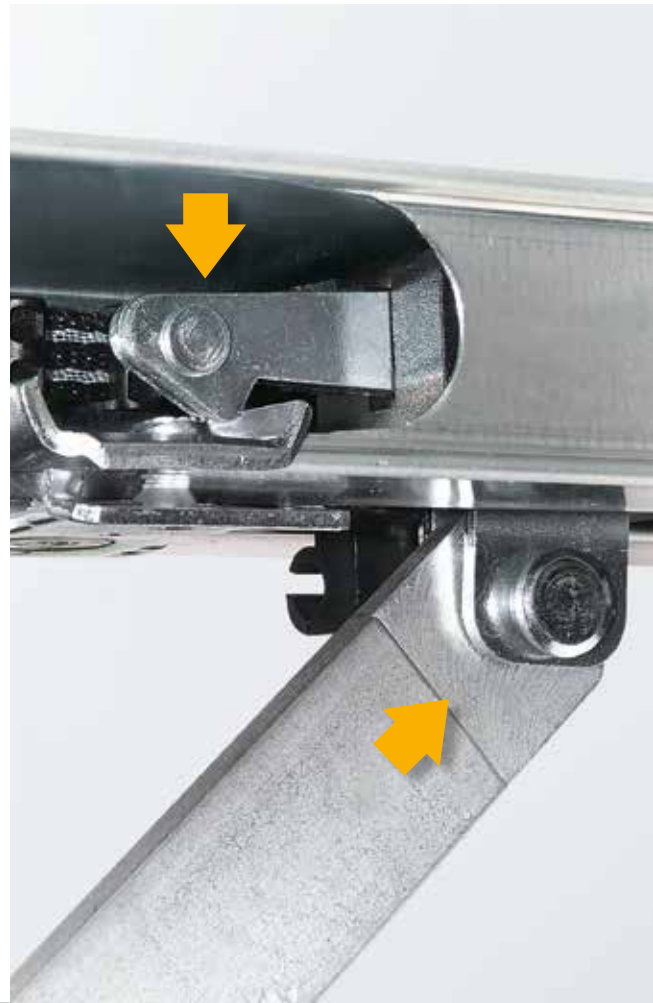

6 Convenient

Side sliding sectional doors can also be opened partially to allow pedestrians to pass. This way you can get into your garage faster, for example if you want to get your bicycle out.



The passage width can be individually set in doors with an operator. The door is operated via the hand transmitter or the optional door handle with radio module.

For further information, please see page 18.

7 Secure

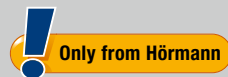

Mechanical anti-lift kit in the operator boom

Uninvited guests barely stand a chance with Hörmann's automatic sectional doors. When the garage door is closed, the **anti-lift kit** automatically engages in the operator boom's stop, then **locks immediately and is secured against forced opening**. This patented door locking functions purely mechanically and, in contrast to competitor operators, continues to secure the door even when the power fails. Additionally, two hooks on the sides of the door connect the end of the door leaf firmly with the side frame.



Watch the video at:
www.hoermann.com/videos



8 BiSecur radio system with certified security

 Only from Hörmann

The bi-directional BiSecur radio system is based on **future-oriented technology** for the convenient and secure operation of garage and entrance gate operators, door operators, lighting and more. The extremely secure BiSecur encryption protocol, developed by Hörmann, with a stable, interference-free range makes sure that no-one can copy your radio signal. It was tested and certified by security experts at Bochum University.



Watch the video at:
www.hoermann.com/videos

9 Perfectly matched and 100 % compatible

All BiSecur operators, receivers and control elements are 100 % compatible. Using a hand transmitter or radio code switch, for example, you can conveniently operate your garage door as well as an entrance gate equipped with a Hörmann operator, your door operators or other devices with BiSecur receivers. With our app* and Hörmann BiSecur gateway, you can conveniently control your Hörmann garage door or entrance gate operators, Hörmann entrance door** or the internal door operator PortaMatic as well as other devices using your **smartphone or tablet.**

* For smartphones or tablets with iOS or Android operating system

** To use this function it is required that your Hörmann entrance door ThermoCarbon / ThermoSafe is equipped with the automatic lock S5 / S7 Smart.



10 Convenient querying of the door position

You no longer have to go out in all kinds of weather to check if your door is closed. At the press of a button, the colour of the LED on the HS 5 BS hand transmitter indicates the position of the door. If required, another push of a button*** closes the door. It is the most comfortable and secure way to control your door.

*** An additional photocell is required for operation without visual contact to the door.

11 Award-winning design

In addition to a black or white design, the **exclusive BiSecur hand transmitters** are characterised by an elegant shape that fits easily in the palm of your hand.

Hörmann BiSecur hand transmitters with an optional high-gloss surface in a piano lacquer look have received the reddot design award for their exclusive design.



Watch the video at:
www.hoermann.com/videos

Figure above: Hand transmitter HS 5 BS with hand transmitter station (optional).

Side sliding sectional doors HST

The 42-mm-thick, PU-foamed sandwich panels are characterised by excellent acoustic and thermal insulation, in addition to good door leaf stability and quiet operation.



M-ribbed, Traffic white, RAL 9016



L-ribbed, Traffic white RAL 9016



L-ribbed, Traffic white RAL 9016
Style 461 with glazing
Style 451 without glazing (not shown)

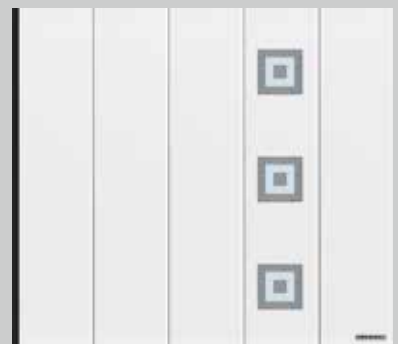

L-ribbed, Traffic white RAL 9016
Style 462 with glazing
Style 452 without glazing (not shown)



L-ribbed, Traffic white RAL 9016
Style 454



L-ribbed, Traffic white RAL 9016
Style 469 with glazing
Style 459 without glazing (not shown)

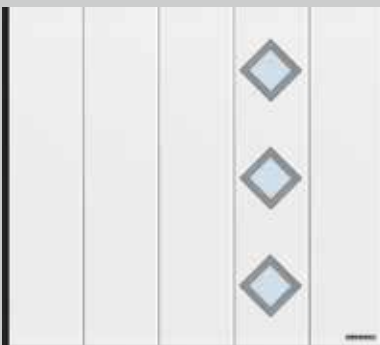

L-ribbed, Traffic white RAL 9016
Style 481 with glazing
Style 471 without glazing (not shown)

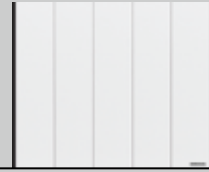

	M-ribbed	L-ribbed
Woodgrain	Traffic white RAL 9016 15 preferred colours RAL to choose	Traffic white RAL 9016 15 preferred colours RAL to choose
Sandgrain	Traffic white RAL 9016 3 preferred colours	Traffic white RAL 9016 3 preferred colours
Silkgrain	Traffic white RAL 9016 15 preferred colours RAL to choose	Traffic white RAL 9016 15 preferred colours RAL to choose
Decograin*	Golden Oak, Dark Oak, Night Oak, Rosewood, Winchester Oak, Titan Metallic CH 703	Golden Oak, Dark Oak, Night Oak, Rosewood, Winchester Oak, Titan Metallic CH 703
Max. width	6500 mm	6500 mm
Max. height	3000 mm	3000 mm

* L-ribbed with design elements not available with Decograin surface



Performance characteristics according to European standard 13241-1

Thermal insulation

Section	$U = 0.5 \text{ W}/(\text{m}^2\cdot\text{K})$
Fitted door*	$U = 1.9 \text{ W}/(\text{m}^2\cdot\text{K})$

Sealing

Air	Class 0
Water	Class 0

Wind load	Class 3
-----------	---------

* The U-value applies to fitted doors without glazing with the dimensions: 5000 × 2125 mm

The example styles show doors with the dimensions 2500 × 2125 mm. The following pages illustrate all of the colours, technical data can be found from page 28 onwards.

It's your choice

Customise your garage door to fit your needs. You can choose from up to 4 surfaces that you can adapt to match the colour of your home. Additionally, you can choose from 15 equally-priced preferred colours, approx. 200 RAL colours and 3 Decograin decors. The door surfaces are optimally protected against rust, allowing you to enjoy your new door for a long time. Rain runs off without leaving any streaky marks thanks to the use of hot-galvanized material and a high-quality polyester-primer coating on both sides.

Steel surface finishes

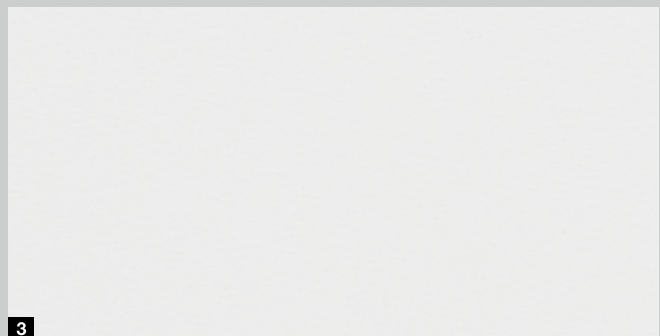

Please note:

Side sliding sectional doors are generally supplied in Grey white, RAL 9002, on the inside of the door.

Dark colours should not be used for double-skinned steel doors that are exposed to the sun, as possible section deflection may restrict the door's function.

All colours are based on RAL. The colours and surfaces shown are subject to the limitations of the printing process and cannot be regarded as binding. Please consult with your Hörmann partner.

1 Woodgrain

On this inexpensive, robust surface with an authentic sawn timber look, minor scratches can be easily repaired by working with the texture.

2 Sandgrain

The finely structured surface is an ideal choice for price-conscious owners and is particularly suited for modern homes.

3 Silkgrain

Thanks to its elegant door appearance, the silky smooth Silkgrain surface is the first choice for modern architecture.

4 Decograin

The Decograin surface gives your sectional door a striking and authentic timber look or an elegant metallic appearance in Anthracite.

Standard colour



15 preferred colours

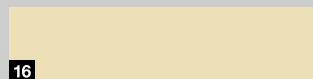
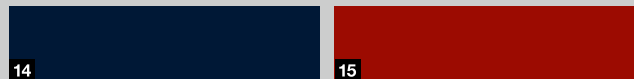
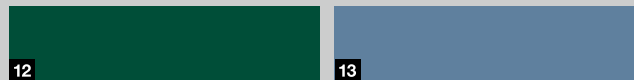

- 1 RAL 9016 Traffic white
- 2 RAL 9007 Grey aluminium
- 3 RAL 9006 White aluminium*
- 4 RAL 8028 Terra brown*
- 5 RAL 8003 Clay brown
- 6 RAL 8001 Ochre brown
- 7 RAL 7040 Window grey
- 8 RAL 7035 Light grey
- 9 RAL 7030 Stone grey
- 10 RAL 7016 Anthracite grey*
- 11 RAL 6009 Fir green
- 12 RAL 6005 Moss green
- 13 RAL 5014 Pigeon blue
- 14 RAL 5011 Steel blue
- 15 RAL 3003 Ruby red
- 16 RAL 1015 Light ivory

6 Decograin decors

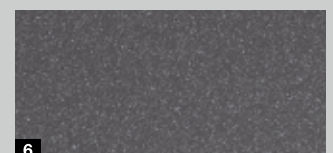

- 1 Decograin Golden Oak: medium brown, golden yellow oak decor
- 2 Decograin Dark Oak: walnut-coloured oak decor
- 3 Decograin Night Oak ■ **NEW**: dark, intense oak design
- 4 Decograin Rosewood ■ **NEW**: mahogany-coloured timber design
- 5 Decograin Winchester Oak ■ **NEW**: natural-coloured knotty oak design
- 6 Titan Metallic CH 703: Anthracite with a metallic effect

* Preferred colours for Sandgrain surface finish

The elegance of side sliding sectional doors

Create your dream door choosing from seven door styles, ranging from the classic panelled look, elegant M and L-ribbings, to exclusive designs with glazings and stainless steel embellishments. Thanks to the wide range of surfaces, colours, and decors, you can perfectly match your side sliding sectional door to the architectural style of your home.





THE ELEGANCE OF SIDE SLIDING SECTIONAL DOORS



▲ L-ribbed, style 461, Hörmann colour CH 703

▶ L-ribbed, Traffic white RAL 9016





◀ M-ribbed, Decograin Golden Oak





Automatic wicket door function for doors with operators

Using a hand transmitter or the handle on the door, you can partially open your side sliding sectional door to allow pedestrians to pass. A brief actuation of the handle and the door automatically moves into the set position. Actuating the handle again closes the door. You can easily adjust the clear passage width with the operator. For example, a narrow passage for persons or a wider passage for bikes, motorcycles or wheelbarrows.



Integrated lockable handle with full radio internal push button functions

Two buttons and a sliding switch on the interior side of the handle allow you to:

- 1 Completely open and close the door
- 2 Operate the wicket door function
- 3 Switch off the radio signal (away setting)



White aluminium RAL 9006



Traffic white RAL 9016



Brown



Brushed stainless steel



Standard door handle position for M and L-ribbing



Door handle position for intermediate widths for M and L-ribbing



Glazing S0



Glazing S1



Glazing S2

4 handle colours

Manually operated doors are supplied as standard with a handle in White aluminium. Three additional colours are optionally available.

The same versions are also available for automatic doors with automatic wicket door function.

3 glazings

The glazings for the top door area are available with a synthetic double pane, either clear or crystal structure. The frames are white as standard and can optionally be delivered in the colour of the door or in RAL to choose.



Ventilation grilles
Ventilation cross section
40 cm²/grille

Ventilation grilles

The ventilation grilles in the bottom part of the door are available in black as standard, and optionally in the colour of the door or in RAL to choose.

Reliable, secure, 100 % compatible

Hörmann garage door operators are perfectly matched to your Hörmann side sliding sectional door. The result: simple operation, maximum convenience and the greatest operational safety. Using our elegant hand transmitters you can conveniently and safely operate your garage door as well as an entrance gate equipped with a fully compatible Hörmann operator or other devices, such as lamps. It goes without saying that our extensive Hörmann programme offers the right operator and accessories for your wishes and needs.



Garagen- und Einfahrtstor-Antriebe

More information can be found in the Garage Door and Entrance Gate Operators brochure.







SupraMatic

The supra-fast operator with many additional functions

- As standard with 5-button hand transmitter HS 5 BS and a HSE 4 BS
- Querying of the door position
- Low power consumption
- Easy to program
- 2x 7-segment display
- Separately switchable LED illumination with energy efficiency class A++
- Adjustable partial opening
- Operator cover made of brushed aluminium
- Automatic door locking
- Double automatic safety cut-out in the Open and Close directions



HS 5 BS
textured
black with
chrome caps



HSE 4 BS
textured black
with plastic caps

	SupraMatic E
Cycles per day / hour	25 / 10
Pull and push force	650 N
Peak force	800 N
Max. opening speed	12 – 18 cm/s
Max. door width	6500 mm
Max. door surface	15 m ²



ProMatic – the good-value starter model as an introduction to Hörmann’s premium quality

- As standard with two 4-button hand transmitter HSE 4 BS
- Adjustable partial opening
- Automatic door locking
- Double automatic safety cut-out in the Open and Close directions
- LED illumination with energy efficiency class A++



HSE 4 BS textured black with plastic caps

	ProMatic
Cycles per day / hour	12 / 5
Pull and push force	600 N
Peak force	750 N
Max. opening speed	8 – 10 cm/s
Max. door width	3000 mm
Max. door surface	9 m ²

* The complete warranty conditions can be found at: www.hoermann.com



Hand transmitter HS 5 BS

4 button functions
plus query button

- 1 High-gloss surface black or white
- 2 Textured surface black



Hand transmitter HS 4 BS

4 button functions,

- 3 Textured surface black

Hand transmitter HS 1 BS

1 button function,

- 4 Textured surface black

Hand transmitter HSE 1 BS

1 button function incl. eyelet
for key ring

- 5 Textured surface black



Hand transmitter HSE 4 BS

4 key functions,
including. eyelet for key ring

- 6 Textured surface black
with chrome or plastic caps

Hand transmitter HSE 2 BS

2 button functions,
incl. eyelet for key ring

- 7 High-gloss surface black
or white

- 8 High-gloss surface green,
purple, yellow, red, orange

- 9 Decors in silver, carbon,
dark rootwood



(Shown from left to right)



10 Hand transmitter HSD 2-A BS
Aluminium look,
2 button functions,
can also be used as a key ring

11 Hand transmitter HSD 2-C BS
High-gloss chrome,
2 button functions,
can also be used as a key ring



**16 Radio code switch
FCT 3 BS**
For 3 functions,
with illuminated buttons



**17 Radio code switch
FCT 10 BS**
For 10 functions,
with illuminated buttons
and protective cover



12 Hand transmitter HSP 4 BS
4 button functions,
with button lock-out,
incl. key ring



**18 Radio finger-scan
FFL 12 BS**
For 2 functions
and up to 12 fingerprints



**13 Hand transmitter
HSZ 1 BS**
1 button function,
for insertion in vehicle
cigarette lighter

**14 Hand transmitter
HSZ 2 BS**
2 button functions,
for insertion in vehicle
cigarette lighter



**15 Radio internal push
button FIT 2-1 BS**
For 2 functions,
connection option for
max. 2 control elements
via cable, e.g. key switch



Key switch
19 STAP 50
20 STUP 50
In a recessed version
and surface-mounted version,
incl. 3 keys

Details perfectly matched to each other

The Hörmann side sliding sectional door combines several innovative details – starting with the precise door travel and the secure locking to the special design of the floor rail. Hence this door solution offers you more convenience and security every day.

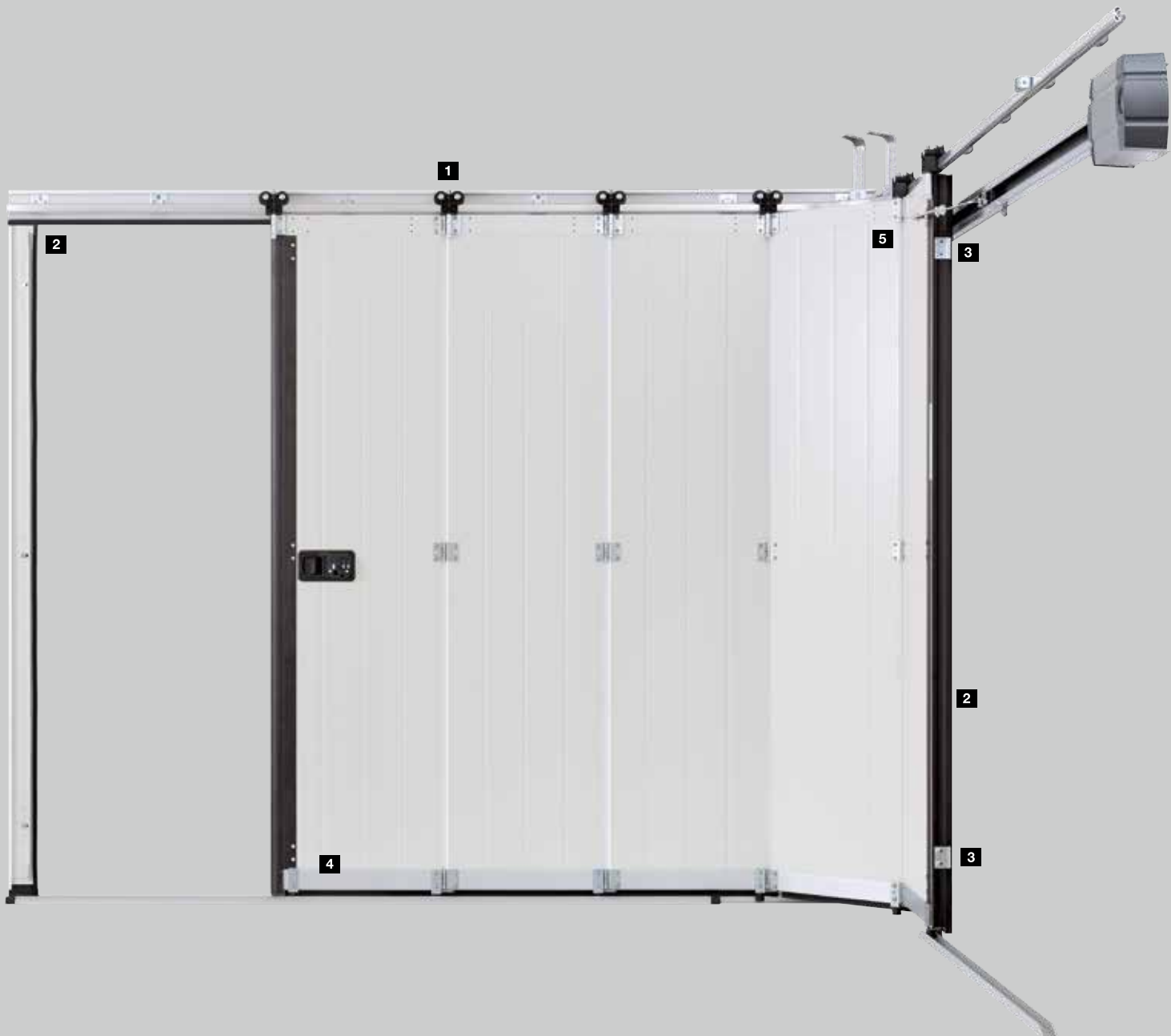



Precise door travel

Twin rollers **1** made of wear-resistant plastic move reliably and precisely on the aluminium rail and prevent the door sections from jumping out. Additionally, they ensure smooth and easy door travel, making it easy to manually open the door. Stable connecting hinges on the rollers and between the PU-foamed 42-mm-thick sections ensure high door leaf stability.



Well-sealed

Flexible and weather-resistant seals **2** on the sides and in the lintel area of the door frame, as well as between the individual door sections and at the bottom edge provide for good door sealing. The side seal optimally fills the door gap with a large-sized profile lip.



Securely locked

The bottom and top door guides close the door precisely. Two additional hooks **3** on the sides of the door connect the end of the door leaf tightly with the side frame. In addition, this mechanical lock prevents the door from being forced open. To improve break-in resistance, manually operated doors can be optionally equipped with 3-point locking at the closing edge.



Well-guided

The bottom aluminium floor rail **4** reliably guides the door sections and prevents the sections from swivelling out. A flat design of only 25 mm makes it easy to drive in and out. It is easy to clean out dirt and leaves from the floor rail, as it is open on the ends.



Easy fitting

The frame of the side sliding sectional door can be easily screwed together and can subsequently be fastened completely to the garage wall. Fitting in tight spaces with a sideroom of only 140 to 450 mm is made possible with track application DS **5** with double side guides.

Determination of operator boom (track application ES and DS)

Door width (LZ)	Operator boom	Distance back (overall length of operator SupraMatic / ProMatic)
≤ 2205	K	3200
≤ 2375	M	3450
≤ 3000	L	4125
≤ 3275	XL	4375
≤ 4750	5500	5725
≤ 6500	7000	7225

The distance back (overall length of operator) can be shortened on-site up to LZ + 1100 mm.

The side guide can be set back up to 125 mm if the distance back (overall length of operator) is smaller than LZ + 1100 mm.

Explanations

RM	Grid height (ordering size)
LZ	Clear frame dimensions (ordering size)
LDH	Clear passage height
LDB	Clear passage width
ET	Distance back (overall length with operator)
OFF	Finished floor level
ASS	Closing side sideroom
AKS	Curve side sideroom

For further information, please see the technical manual or contact your Hörmann partner.

Track application ES (single track, operator ceiling fitting A)

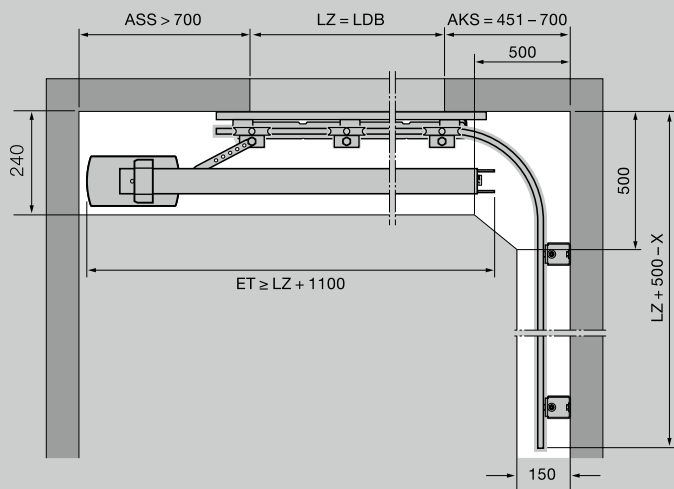

Track application ES (single track, operator ceiling fitting B)

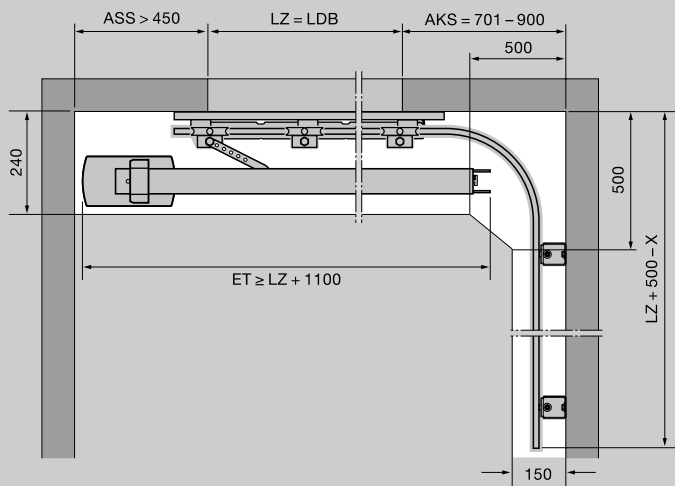

Vertical views

Ceiling fitting B

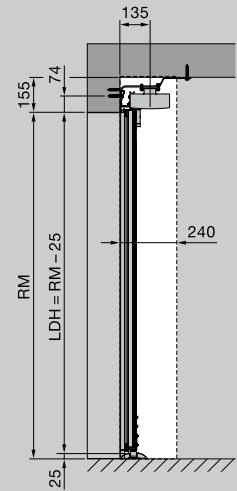

Wall fitting

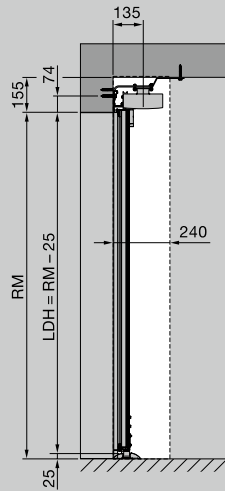

Horizontal views

Ceiling fitting B (floor rail view)

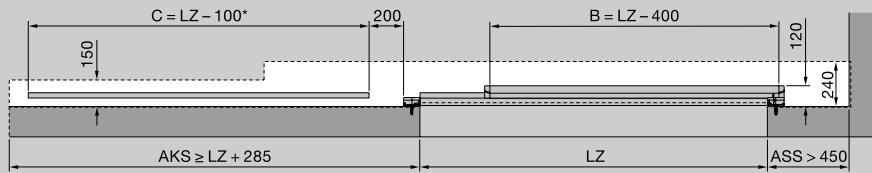

Wall fitting (floor rail view)

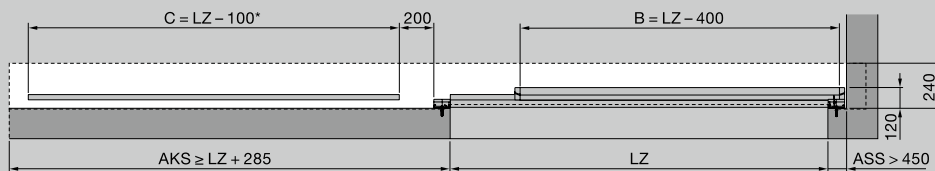

Explanations

- RM Grid height (ordering size)
- LZ Clear frame dimensions (ordering size)
- LDH Clear passage height
- LDB Clear passage width
- ET Distance back (overall length with operator)
- OFF Finished floor level

- ASS Closing side sideroom
- AKS Curve side sideroom

¹⁾ LZ > 5000 two-part version

For further information, please see the technical manual or contact your Hörmann partner.

Experience Hörmann quality in new construction and modernisation

Hörmann provides an excellent basis for comprehensive planning. Carefully matched solutions offer you the very best in perfectly designed products for every area.

- **Garage doors**

Optimally match your personal architectural style: up-and-over or sectional doors made of steel or timber.

- **Gate and Door Operators**

Enjoy extra convenience and break-in-resistant security with Hörmann operators for garage doors and entrance gates. You can profit from the convenience of Hörmann door operators in your residential space as well.

- **Entrance doors**

Our comprehensive entrance door ranges include models that fit almost every need and requirement.

- **Steel doors**

Sturdy doors for your entire home, from basement to roof.

- **Frames**

Choose from our comprehensive range of products for new construction, expansion and modernisation.



Garage doors and entrance gate operators



Thermo65 / Thermo46 entrance doors



Steel doors

Hörmann: Quality without Compromise



Hörmann KG Amshausen, Germany



Hörmann KG Antriebstechnik, Germany



Hörmann KG Brandis, Germany



Hörmann KG Brockhagen, Germany



Hörmann KG Dissen, Germany



Hörmann KG Eckelhausen, Germany



Hörmann KG Freisen, Germany



Hörmann KG Ichttershausen, Germany



Hörmann KG Werne, Germany



Hörmann Alkmaar B.V., Netherlands



Hörmann Legnica Sp. z o.o., Poland



Hörmann Beijing, China



Hörmann Tianjin, China



Hörmann LLC, Montgomery IL, USA



Hörmann Flexon LLC, Burgettstown PA, USA



Shakti Hörmann Ltd., India

Hörmann is the only manufacturer worldwide that offers you a complete range of all major building products from one source. We manufacture in highly-specialised factories using the latest production technologies. The close-meshed network of sales and service companies throughout Europe, and activities in the USA and Asia, make Hörmann your strong partner for first-class building products, offering "Quality without Compromise".

GARAGE DOORS
OPERATORS
INDUSTRIAL DOORS
LOADING EQUIPMENT
HINGED DOORS
DOOR FRAMES