



Double and Collective Garage Doors

Non-protruding up-and-over door ET 500, sliding door ST 500, up-and-over door N 500

HÖRMANN



!
Straßenengpässe

Kein Einparken
in diesem Bereich

CONTENT

4	Good reasons to try Hörmann
10	Door types
12	Design overview of double and collective garage doors
14	General overview
16	Styles
20	Colour
22	Up-and-over door N 500
24	Non-protruding up-and-over door ET 500
26	Sliding door ST 500
28	Wicket doors and side doors
30	Garage door operators
34	Mobile accessories
36	Dimensions and fitting data
43	Hörmann product range

Some of the doors shown are equipped with optional extras and do not always correspond to our standard models.

The surface finishes and colours shown are subject to the limitations of the printing process and cannot be regarded as binding.

All rights reserved. No part may be reproduced without our prior permission. Subject to changes.

◀ Non-protruding up-and-over door ET 500, style 405 with on-site cladding

“A good reputation must be earned.”

August Hörmann

In line with the founder's philosophy, the Hörmann brand today is a true promise of quality. The family-owned company has over 80 years of experience in door and operator construction and, with sales of over 20 million doors, is no. 1 in Europe. This gives you a reassuring feeling when purchasing a Hörmann double and collective garage door.



1 Brand quality “Made in Germany”

All doors and operator components developed and manufactured by Hörmann, are **perfectly matched to each other** and **tested and certified** by independent, recognised institutes to ensure your safety. They are manufactured in Germany according to the DIN ISO 9001 quality management system and meet the requirements of European standard 13241-1. Furthermore, our highly qualified employees work intensively on new products, continual further developments and improvements to details. The results are patents and one-of-a-kind products you can depend on.



2 Garage doors for generations

Endurance tests under real conditions ensure mature series products with Hörmann quality. Thanks to this, as well as excellent technical solutions and uncompromising quality assurance, **you can enjoy Hörmann double and collective garage doors for years to come.**

3 An eye on the future

Hörmann is setting a good example. This is why the company has obtained **over 70 % of its required energy from green sources** and will continue to increase this percentage. At the same time, many tonnes of CO₂ are saved each year thanks to the introduction of an intelligent and certified energy management system. And last but not least, Hörmann offers products for sustainable construction. Find out more about Hörmann's environmental activities in the "We Think Green" brochure.



4 Smooth, quiet door travel even at high frequencies

Twin rollers in the guide rail and guide rollers with ball-bearings allow the door to operate **smoothly, quietly and precisely** – even in continuous use. The non-protruding up-and-over door ET 500 and the sliding door ST 500 are designed for a service life of at least 250,000 door cycles; the up-and-over door N 500 optionally reinforced with spring assembly for at least 100,000.

5 All-round well secured design

The open design with safety clearance between the door leaf and building structure offers **reliable protection against finger injuries** on the side and bottom edges. A special EPDM profile shape protects the closing edge of the door leaf. For non-protruding up-and-over door ET 500 and sliding door ST 500 an integrated photocell also secures the door opening.



6 Approved door and operator unit

All double and collective garage doors are always tested and certified by independent, recognised institutes together with their corresponding operators. This ensures that the **door and operator unit** run smoothly and securely, which is especially important when fitting the door in public areas, such as underground and collective garages. This is especially important when fitting the door in public areas, such as underground and collective garages.



7 Practical wicket doors and side doors

On request, double and collective garage doors are also available **with a practical wicket door or with a side door matching the design**. Wicket doors can be arranged left, right or centre. Overhead door closers are part of the standard scope of delivery.



8 BiSecur radio system with certified security

 **Only from Hörmann**

The bi-directional radio system BiSecur is based on **future-oriented technology** for the convenient and secure operation of garage and entrance gate operators, door operators, lights and more. The extremely secure BiSecur encryption protocol, developed by Hörmann, with a stable, interference-free range makes sure that no-one can copy your radio signal. It was tested and certified by security experts at Bochum University.



Take a look at the video at:
www.hormann.co.uk/videos



Perfectly matched and 100 % compatible

All BiSecur operators, receivers and control elements are 100 % compatible. Using a hand transmitter or radio code switch, for example, you can conveniently operate your garage door as well as an entrance gate equipped with a Hörmann operator, your door operators or other devices with BiSecur receivers.

With our app* and Hörmann BiSecur gateway, it is easy to control your Hörmann garage door or entrance gate operators, Hörmann entrance door** or the internal door operator PortaMatic as well as other devices using your **smartphone or tablet**.

* For smartphones or tablets with iOS or Android operating system

** To use this function it is required that your Hörmann entrance door ThermoCarbon/ ThermoSafe is equipped with the automatic lock S5/S7 Smart.



9 Convenient querying of the door position

You no longer have to go out in all kinds of weather to check if your door is closed. At the press of a button, the colour of the LED on the HS 5 BS hand transmitter indicates the position of the door. If required, another push of a button*** closes the door. It is the most comfortable and secure way to control your door.

*** An additional photocell is required for operation without visual contact to the door.

10 Award-winning design

In addition to a black or white design, the **exclusive BiSecur hand transmitters** are characterised by an elegant shape that fits easily in the palm of your hand.

Hörmann's BiSecur hand transmitters with an optional high-gloss surface in a piano lacquer look have received the reddot design award for their exclusive design.



Take a look at the video at:
www.hormann.co.uk/videos



Figure above: HS 5 BS hand transmitter with hand transmitter station (optional).

Three versions – one quality

The swinging up-and-over door N 500 is suited for double garages in private areas and for collective garages for up to 25 parking spaces.

When opening and closing, the non-protruding up-and-over door ET 500 swings out only to 40 mm and is therefore optimal for collective garages opening onto pavements.

The design of the ST 500 sliding door additionally features a low fitting depth in the lintel area.

All door types together offer a wide variety of styles and individual design options. For further information, please see pages 22 – 27.



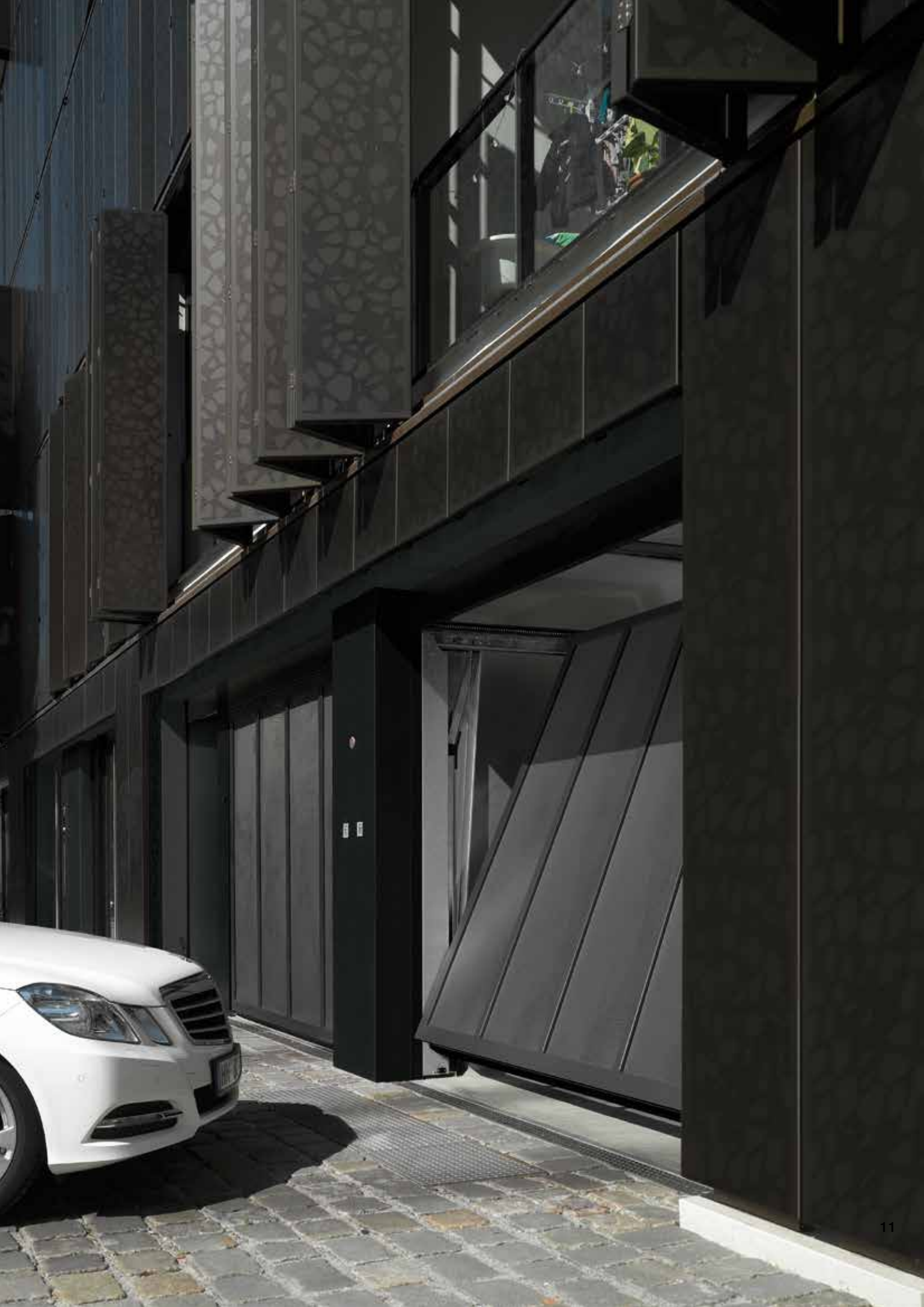

DESIGN OVERVIEW OF DOUBLE AND COLLECTIVE GARAGE DOORS

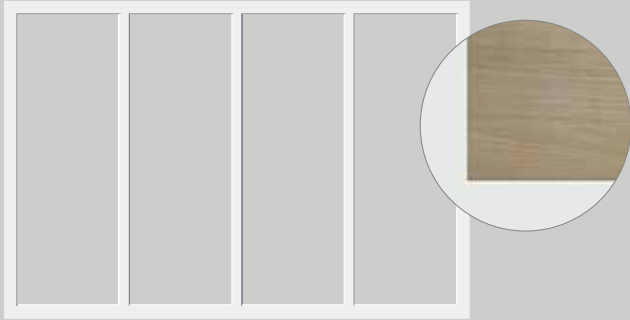

Style 400
Frames for on-site infill inside the frame
(detail figure shows infill example)

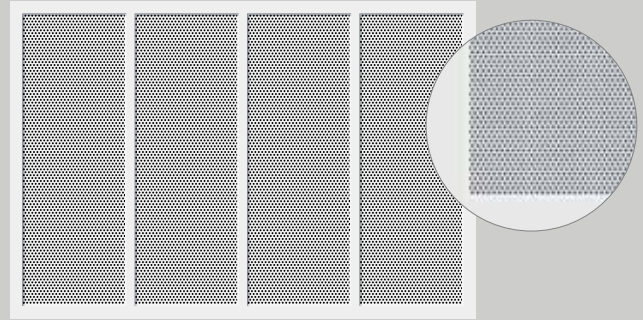

Styles 412 and 432
Internal perforated sheet infill with round recesses

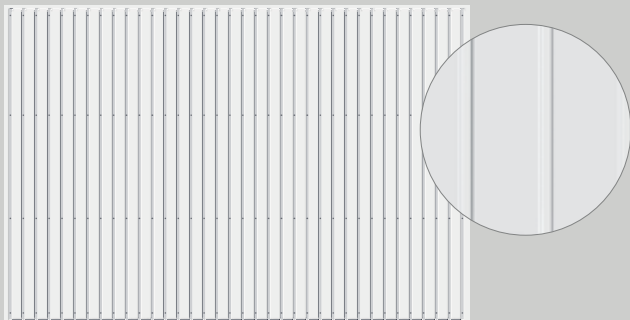

Style 402
Surface-mounted, ribbed sheet steel infill

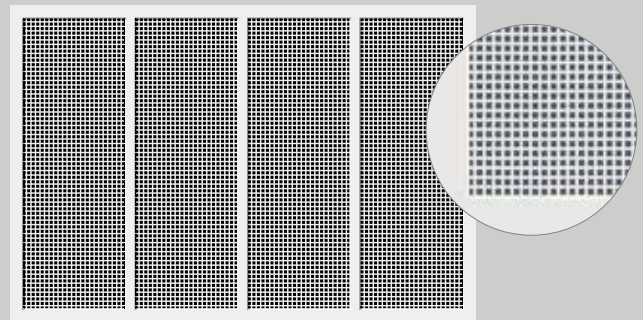

Styles 413 and 433
Internal perforated sheet infill with square recesses

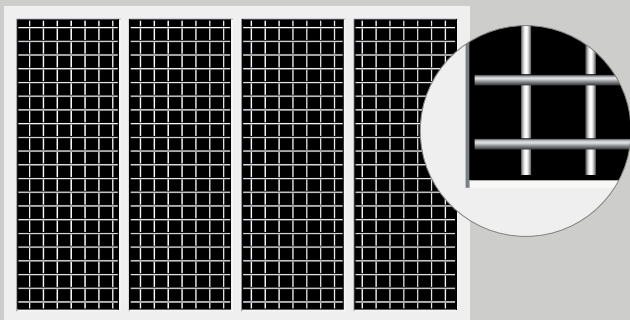

Style 403
Internal welded grille infill

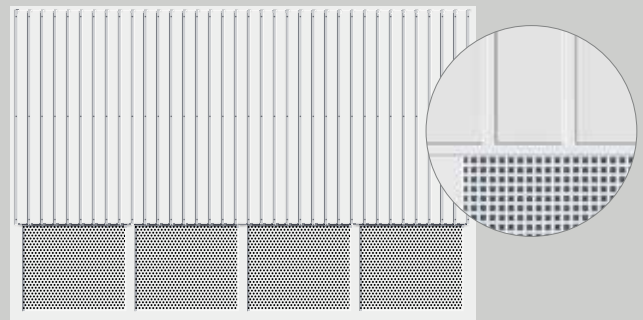

Style 414
Surface-mounted, ribbed sheet steel
with perforated sheet infill, round or square

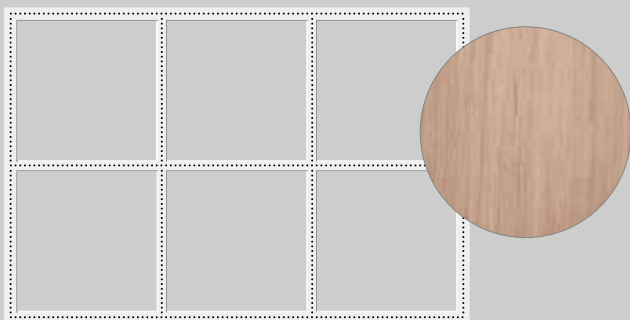

Style 405
Frames for surface-mounted, on-site cladding
(detail figure shows infill example)

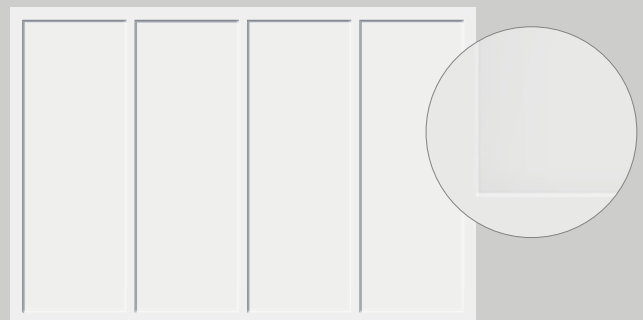

Style 420
Internal, smooth aluminium sheet infill

Information on max. infill weight can be found in the technical manual.



Style 422
Surface-mounted, smooth aluminium sheet

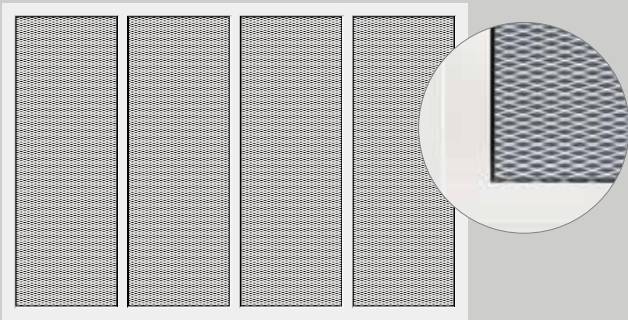

Style 440
Internal expanded mesh infill



Style 480
Internal section infill

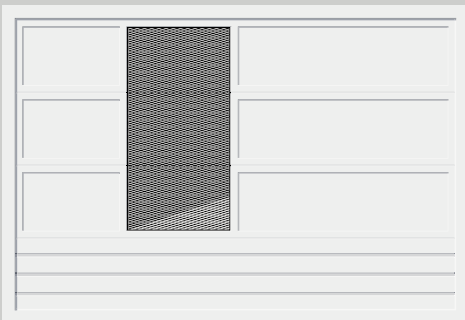

Style 499
Combined infill, individually composed of other style variants (figure shows infill example)

Style 480 variants

The style 480 section infill is optionally available with integrated ventilation grilles. Additionally, the sections can also be individually combined in aluminium frames with glazing or expanded mesh.

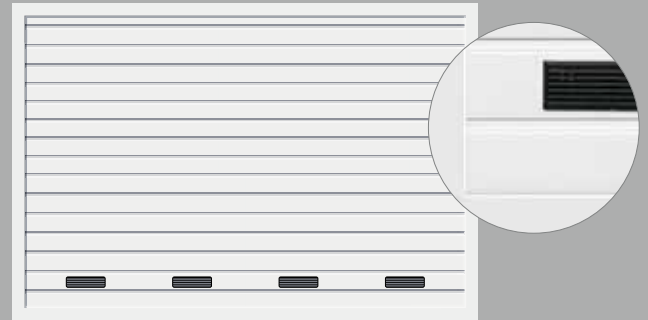

Style 480
Internal section infill with ventilation grilles

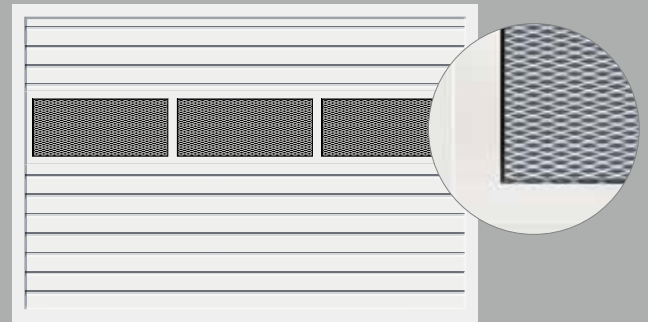

Style 480
Internal section infill with aluminium frame and expanded mesh infill

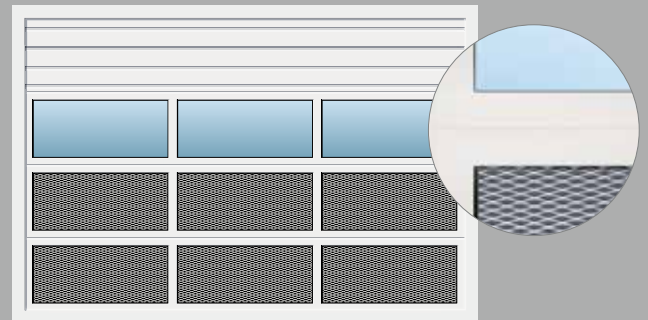

Style 480
Internal section infill with aluminium frame, glazing and expanded mesh infill.

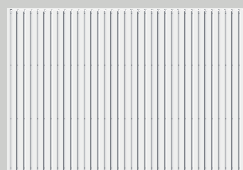

Style	400	402	403
Up-and-over door N 500			
Colour	Traffic white RAL 9016 7 preferred colours RAL to choose	Traffic white RAL 9016 7 preferred colours RAL to choose	Traffic white RAL 9016 7 preferred colours RAL to choose
Max. width (mm)	5000	5000	5000
Max. height (mm)	2750	2750	2750
Non-protruding up-and-over door ET 500 / sliding door ST 500			
Colour	White aluminium RAL 9006 16 preferred colours RAL to choose	White aluminium RAL 9006 16 preferred colours RAL to choose	
Max. width (mm)	6000	6000	
Max. height (mm)	3000	3000	

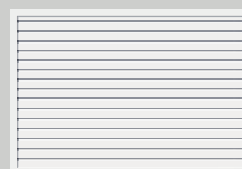
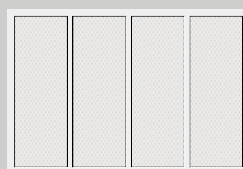
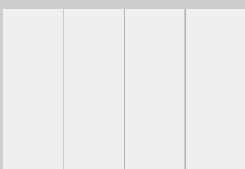

Style	422	440	480
Up-and-over door N 500			
Colour	Traffic white RAL 9016 7 preferred colours RAL to choose	Traffic white RAL 9016 7 preferred colours RAL to choose	
Max. width (mm)	5000	5000	
Max. height (mm)	2750	2750	
Non-protruding up-and-over door ET 500 / sliding door ST 500			
Colour	White aluminium RAL 9006 16 preferred colours RAL to choose	White aluminium RAL 9006 16 preferred colours RAL to choose	White aluminium RAL 9006 16 preferred colours RAL to choose
Max. width (mm)	6000 ¹⁾	6000 ¹⁾	5500 ²⁾
Max. height (mm)	3000	3000	3000

¹⁾ Door width with max. 5500 mm wicket door

²⁾ Door width with max. 5000 mm wicket door

³⁾ Style 432, 433 only available for ET 500 / ST 500

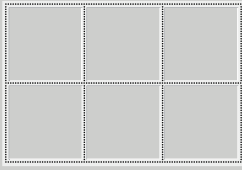

405

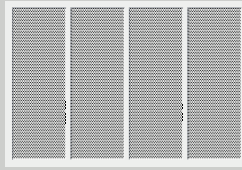

412 / 432 ³⁾

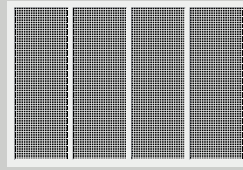

413 / 433 ³⁾



414



420

Terra brown RAL 8028
7 preferred colours
RAL to choose

5000
2750

Traffic white RAL 9016
7 preferred colours
RAL to choose

5000
2750

Traffic white RAL 9016
7 preferred colours
RAL to choose

5000
2750

Traffic white RAL 9016
7 preferred colours
RAL to choose

5000
2750

White aluminium
RAL 9006
16 preferred colours
RAL to choose

6000 ²⁾
3000

White aluminium
RAL 9006
16 preferred colours
RAL to choose

6000
3000

White aluminium
RAL 9006
16 preferred colours
RAL to choose

6000
3000

White aluminium
RAL 9006
16 preferred colours
RAL to choose

6000
3000

White aluminium
RAL 9006
16 preferred colours
RAL to choose

6000 ¹⁾
3000

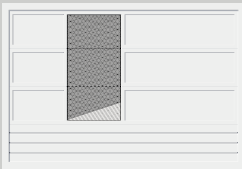

499

White aluminium
RAL 9006
16 preferred colours
RAL to choose

6000
3000





▲ Non-protruding up-and-over door ET 500, style 405,
with on-site cladding, installed flush-fitting





▲ Up-and-over door N 500,
style 402 Window grey RAL 7040

◀ Sliding door ST 500, style 412 Anthracite grey RAL 7016

Beautiful and protective colour

The N 500 up-and-over doors are available as standard in Traffic white RAL 9016 and in 7 preferred colours. The non-protruding up-and-over door ET 500 and the sliding door ST 500 are offered as standard in White aluminium RAL 9006 and in 15 preferred colours.

All door types are also available in around 200 colours based on RAL*. The matching side doors are also offered in all colours of the corresponding door types.

Please note:

All colours based on RAL.

The colours and surfaces shown are subject to the limitations of the printing process and cannot be regarded as binding. Please consult with your local Hörmann specialised dealer.

* RAL Classic colours, with the exception of pearl-effect, fluorescent and metallic colours

** Preferred colours for up-and-over door N 500





Standard and preferred colours



- | | | |
|-----------|----------|---|
| 1 | RAL 9006 | White aluminium** (standard colour ET 500 / ST 500) |
| 2 | RAL 9016 | Traffic white (standard colour N 500) |
| 3 | RAL 9007 | Grey aluminium |
| 4 | RAL 8028 | Terra brown** |
| 5 | RAL 8003 | Clay brown |
| 6 | RAL 8001 | Ochre brown |
| 7 | RAL 7040 | Window grey** |
| 8 | RAL 7035 | Light grey** |
| 9 | RAL 7030 | Stone grey |
| 10 | RAL 7016 | Anthracite grey** |
| 11 | RAL 6009 | Fir green** |
| 12 | RAL 6005 | Moss green |
| 13 | RAL 5014 | Pigeon blue |
| 14 | RAL 5011 | Steel blue |
| 15 | RAL 5003 | Sapphire blue |
| 16 | RAL 3003 | Ruby red |
| 17 | RAL 1015 | Light ivory** |



Calculated design

The sturdy and open construction ensures precise and safe opening and closing. Thanks to the automatic operator locking, the door is secure.

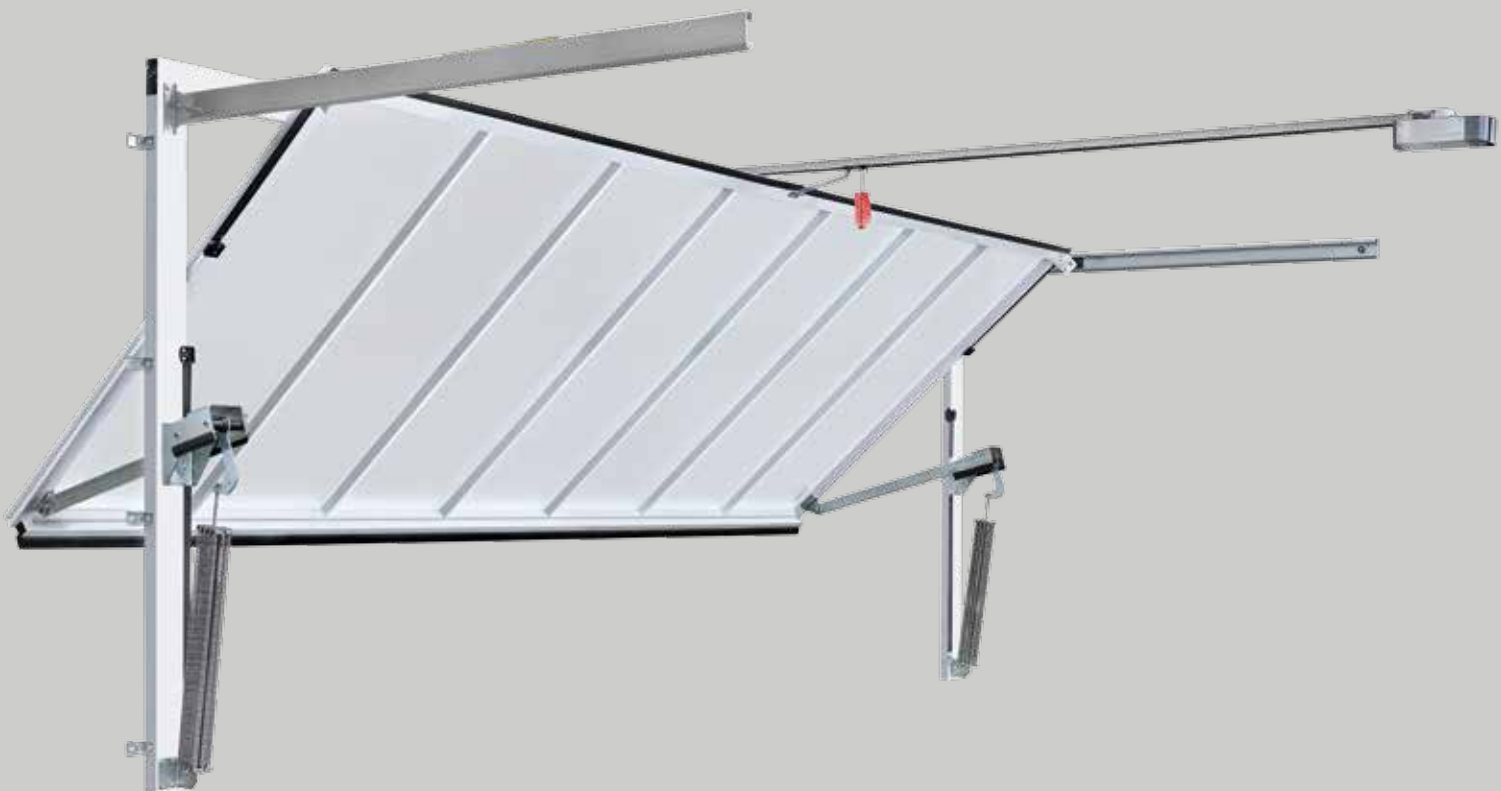



1 Harmonious door appearance

For a harmonious door appearance, the door leaf and subframe are flush-fitting and have the same colour. The door can be flush-fitted with the facade in the reveal or behind it.



2 Safe opening mechanism

Stable lever arms with ball-bearings and track rollers with ball-bearings allow the door to operate smoothly, safely and precisely. The specially dimensioned multiple spring assembly has two functions: it supports safe door opening and closing and at the same time prevents the door leaf from falling. The open design also minimises the risk of crushing.



3 Well-sealed

Double seals on the door's lower edge effectively prevent the ingress of leaves, hail and snow.

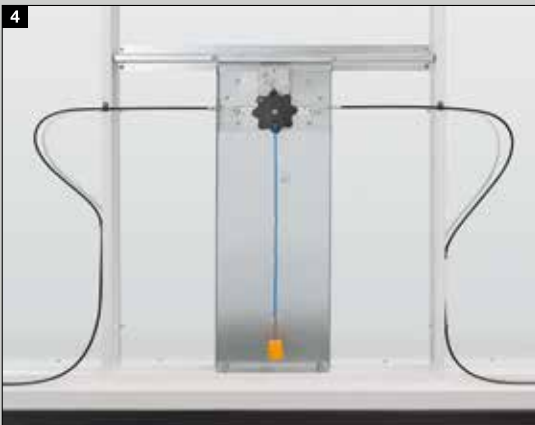

Convenience with operator

The up-and-over door N 500 is designed for the SupraMatic E, SupraMatic P or SupraMatic HT operators. No additional headroom is required for fitting the operator. Optionally, the door can be operated or additionally locked by hand using a handle [4](#). Optional handles for the N 500 can be found in the up-and-over garage doors brochure.

Lasting safe functionality even at high frequencies

The low-maintenance door construction with wear-free counter weight technology opens and closes smoothly, quietly and safely. It is designed for at least 250,000 door cycles. Due to the small frame depth, the space directly next to the door can also be used as a parking space.





1 Quiet door travel without swinging out the door leaf

Precise roller guiding in the guide rail allows the door to run quietly and extremely precisely. If the door is fitted behind the opening or with subframes, the ET 500 can be fitted directly adjacent to the street or pavement, since the door leaf does not swing out.



2 Compact fitting dimensions

The ET 500 requires hardly any space: in combination with an operator, the required headroom is only 100 mm (SupraMatic HT) or 120 mm (ITO 400 FU). The same applies to sideroom: the space requirement here is 140 mm (ET 500 L) or 250 mm (ET 500 S). The small frame depth of max. 450 mm (ET 500 L) or max. 400 mm (ET 500 S) means that the space directly next to the door can also be used as a parking space. Thanks to the minimal distance back there is also more ceiling space.



3 Sturdy and safe construction

The entire door construction is extremely long-lasting and low-maintenance: the wear-free counter weight technology is designed for at least 250,000 door cycles. Double cables also prevent the door leaf from falling.

3 Exemplary safety with integrated photocell

The open construction features the greatest operational safety in rough everyday operation: safety clearance between the door leaf and building structure as well as on the bottom and side edges ensures a reliable trap guard. A special EPDM profile shape secures the closing edge. The integrated photocell is already pre-assembled in the frame and is easily installed on the operator.

Low space requirements for optimised use of space

The collective garage sliding door ST 500 requires very little fitting depth. As a result, parking spaces can also be used directly next to the door. Thanks to the narrow door subframe, it can also be fitted with very low headroom.





1 Particularly space-saving

The small fitting depth of 450 mm incl. operator allows fitting where suspensions have been fitted to the garage ceiling. Thanks to standard subframes, fitting is even possible if no lintel is available

2 Quiet and safe door travel

Twin rollers in the upper guide rail and guide rollers with ball-bearings at the floor offer smooth, quiet door travel and almost silent opening and closing. As a result the door maintains secure travel even in the parking area.

3 Exemplary safety

Safety profiles at the inlet and the closing edge of the door as a standard feature and photocell pre-assembled in the door opening as standard offer full protection against injuries and material damage.



Convenient access to the garage

On request, double and collective garage doors are also available with a practical wicket door or with a side door matching the design.



Wicket doors

With sliding door ST 500, concealed hinges are standard for the wicket door, optionally available for non-protruding up-and-over door ET 500. Overhead door closers are part of the standard scope of delivery for all door variants.





Side doors

The side doors are available as standard with a black plastic lever handle set, prepared for profile cylinder, and a clear passage height of up to 2440 mm.



Reliable, secure, convenient

Hörmann garage door operators and Hörmann collective garage doors are perfectly matched to each other. The result: minimal operational effort, maximum convenience and optimum security.

All doors can be conveniently operated with the elegant hand transmitter, for example when you're in the car. Alternatively, you can control your door using stationary control elements, for example radio code switches or radio finger scans. You can find the comprehensive program of Hörmann control elements and safety accessories in the Hörmann "Door Systems for Collective Garages" brochure or at your local Hörmann dealer.



More information can be found in the Door Systems for Collective Garages brochure





SupraMatic – the supra-fast operator with many additional functions



- As standard with 5-button hand transmitter HS 5 BS
- Inquiry of the door position
- Low power consumption
- Easy to program
- 2 × 7-segment display
- Halogen lighting can be switched on / off separately
- Adjustable ventilation slot
- Automatic door locking
- Operator cover made of brushed aluminium



Standard hand transmitter HS 5 BS black textured surface

Garage door operators	SupraMatic E	SupraMatic P	SupraMatic HT
Up-and-over door N 500	○	○	○
Non-protruding up-and-over door ET 500 / sliding door ST 500			●
Cycles per day / hour	25 / 10	50 / 10	300 / 20
Pull and push force	650 N	750 N	1000 N
Peak force	800 N	1000 N	1200 N
Max. opening speed**	22 cm/s	22 cm/s	22 cm/s
Max. door width	5500 mm	6000 mm	6000 mm
Max. door surface	13.75 m ²	15 m ²	15 m ²

● = Standard ○ = Optional

* The complete warranty conditions can be found at: www.hoermann.com

** The opening speed depends on the door size and door weight.

ITO 400 FU, the powerful operator with soft start and soft stop

- Soft start and soft stop for quiet and gentle door travel
- Optional 2nd opening height
- Emergency release via bowden cable on the slide carriage
- Settings on a separate control via a control panel
- Automatic timer**
- Prepared for traffic control**

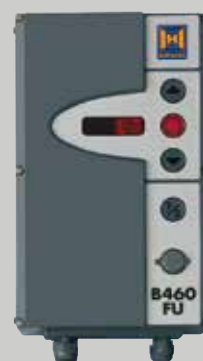

The control for the operator

Using the menu on the optimally matched control for the ITO 400 FU, you can quickly and easily set, for example, desired hold-open times and visual indicators of warning lights.

Garage door operators	ITO 400 FU
Non-protruding up-and-over door ET 500 / sliding door ST 500	○
Cycles per day / hour	450 / 30
Pull and push force	1500 N
Max. opening speed***	25 cm/s
Max. door width	6000 mm
Max. door surface	18 m ²

● = Standard ○ = Optional

* The complete warranty conditions can be found at: www.hoermann.com

** Only in combination with an activating kit for warning light and photocell / light grille

*** The opening speed depends on the door size and door weight.



Hand transmitter HS 5 BS

4 button functions plus query button,
1 high-gloss surface black or white

2 Textured surface black



Hand transmitter HS 4 BS

4 button functions,
3 Textured surface black

Hand transmitter HS 1 BS

1 button function,
4 Textured surface black

Hand transmitter HSE 1 BS

1 button function, incl. eyelet for key ring
5 Textured surface black



Hand transmitter HSE 4 BS

4 key functions, including eyelet for key ring
6 Textured surface black with chrome or plastic caps

Hand transmitter HSE 2 BS

2 button functions, including eyelet for key ring
7 high-gloss surface black or white
8 high-gloss surface green, purple, yellow, red, orange

9 decors in silver, carbon, dark rootwood

(Shown from left to right)





10 Hand transmitter HSD 2-A BS
Aluminium look,
2 button functions,
can also be used as a key ring

11 Hand transmitter HSD 2-C BS
High-gloss chrome,
2 button functions,
can also be used as a key ring



12 Hand transmitter HSP 4 BS
4 button functions,
With button lock-out,
incl. key ring



13 Hand transmitter HSZ 1 BS
1 button function,
for insertion in vehicle
cigarette lighter

14 Hand transmitter HSZ 2 BS
2 button functions,
for insertion in vehicle
cigarette lighter



Key switch post STS

With the key switch post STS, the fitted stationary command units are particularly easy to reach and convenient to operate. The post is anodised aluminium (natural finish) and the top and bottom end of the post are supplied in Slate grey RAL 7015.



Activating kit for warning light and complete traffic controls

Warning lights secure and control the entrance and exit of the door system. Yellow warning lights alert when the door is moving, red/green activating kits for warning lights serve as a visual indicator for controlling the entrance and exit.

You can find additional information about the comprehensive accessory programme in the Door Systems for Collective Garages brochure.

Maximum size ranges

ET 500 L – lightweight version and ST 500 ET 500 S – heavy version and ST 500 N 500

Styles 412, 413
Doors with perforated steel sheet infill

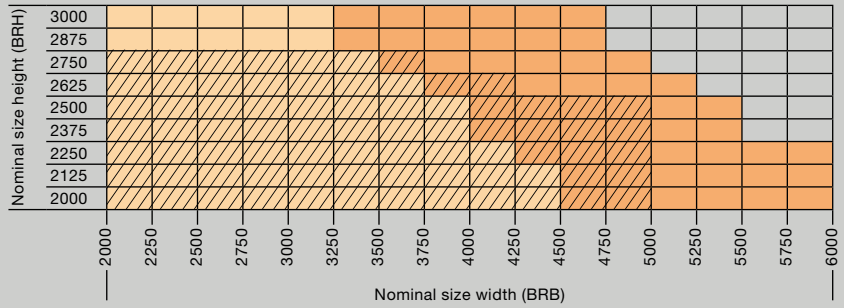

Styles 432, 433
Doors with aluminium perforated sheet infill

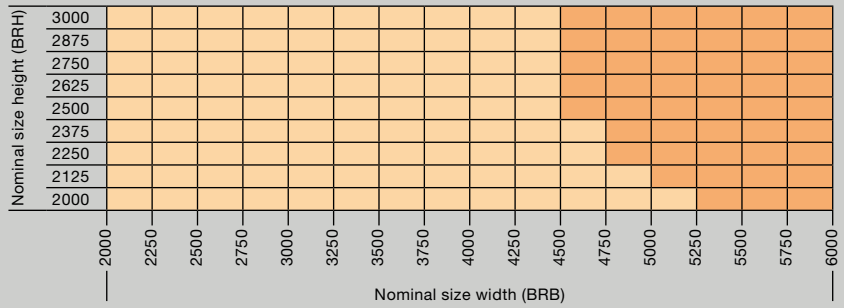

Style 420
Doors with aluminium sheet infill inside the frame

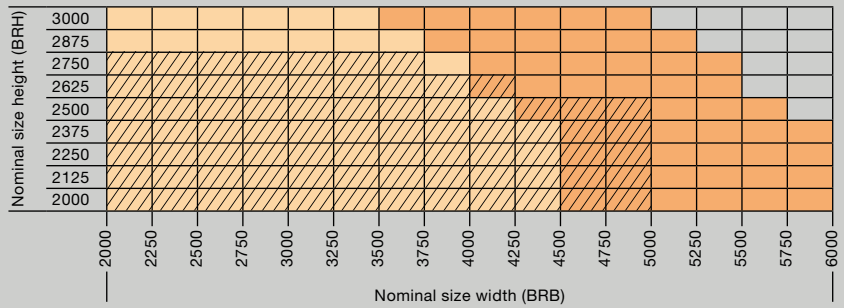

Style 480
Doors with section infill

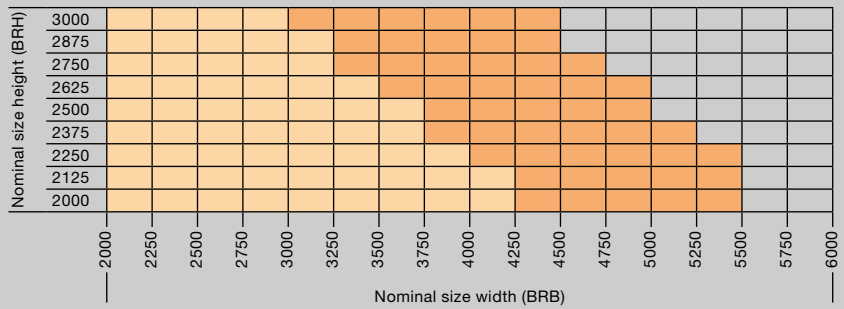

Styles 402, 414
Doors with surface-mounted ribbed sheet infill

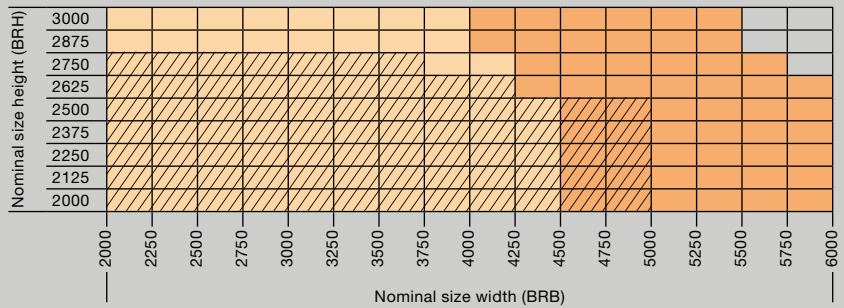

Maximum size ranges

Note

For the maximum infill weight please see the technical manual.

Style 422
Doors with surface-mounted aluminium sheet infill

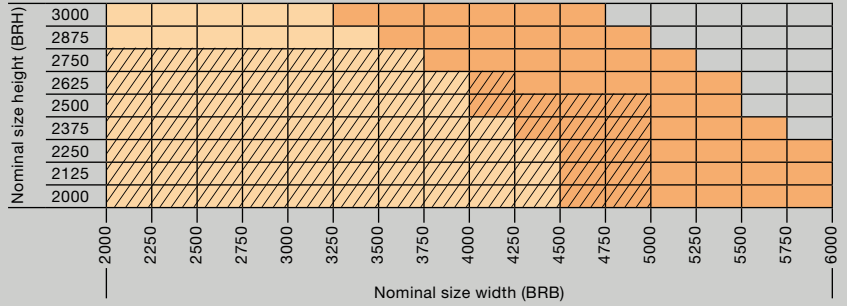

Style 400
Doors for on-site infill inside the frame

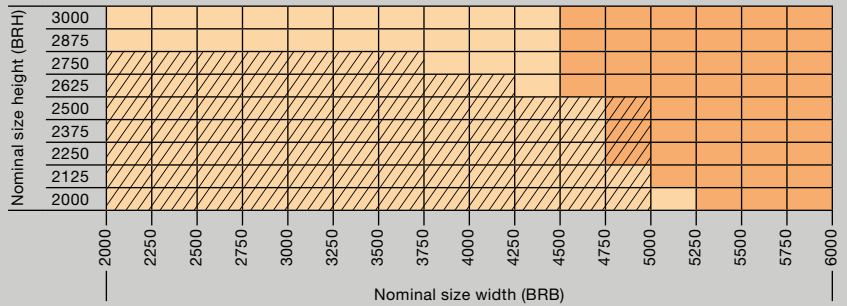

Style 405
Doors for on-site surface-mounted infill

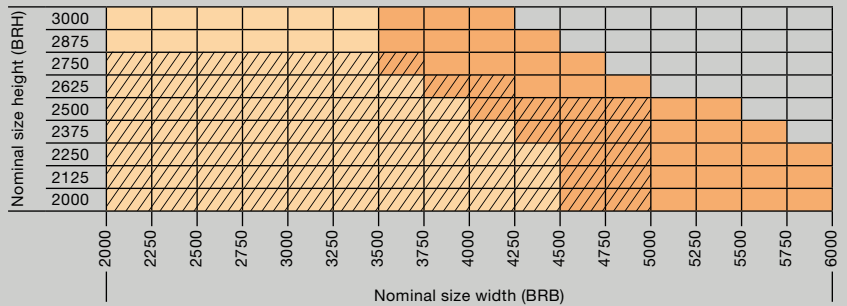

Style 403
Doors with welded grille infill inside the frame

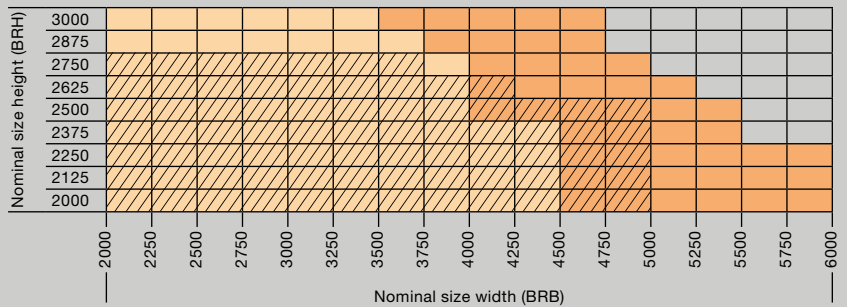

Style 440
Doors with expanded mesh infill inside the frame

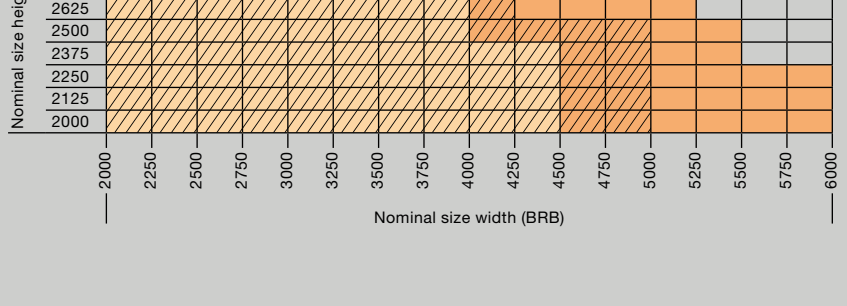

Style 499
Doors with combined infill

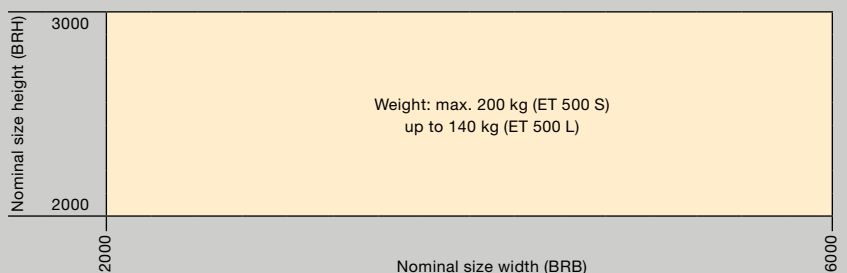

Dimensions in mm

Vertical view N 500

Fitting behind the opening

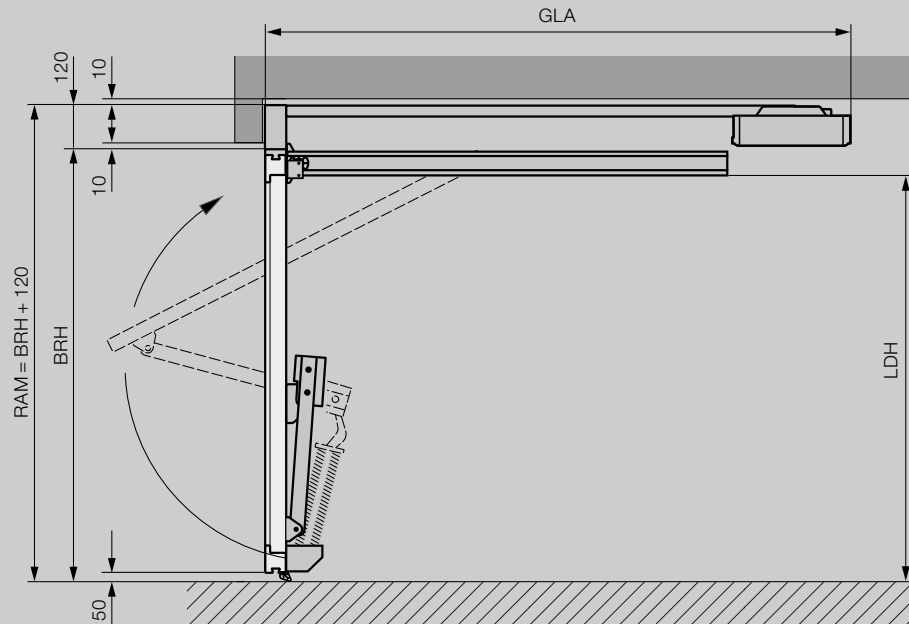

Explanations

- RAM Overall frame dimension
- LH Clear opening height
- LB Clear opening width
- LDH Clear passage height
- LDB Clear passage width
- BRH Nominal height (ordering size)
- BRB Nominal width (ordering size)

Overall length with operator GLA

SupraMatic	
BRH < 2500	3200
BRH < 2750	3450

Clear passage height LDH

BRB < 4000	= BRH - 130
BRB ≥ 4005	= BRH - 170

Clear passage width LDB

LDB	= BRB - 100
-----	-------------

Note

For further information, please see the fitting data or contact your Hörmann partner.

Horizontal view N 500

Fitting behind the opening

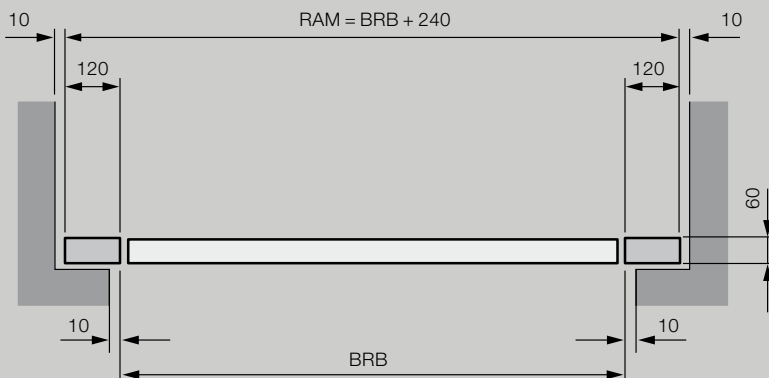

Vertical view ET 500

Fitting behind the opening

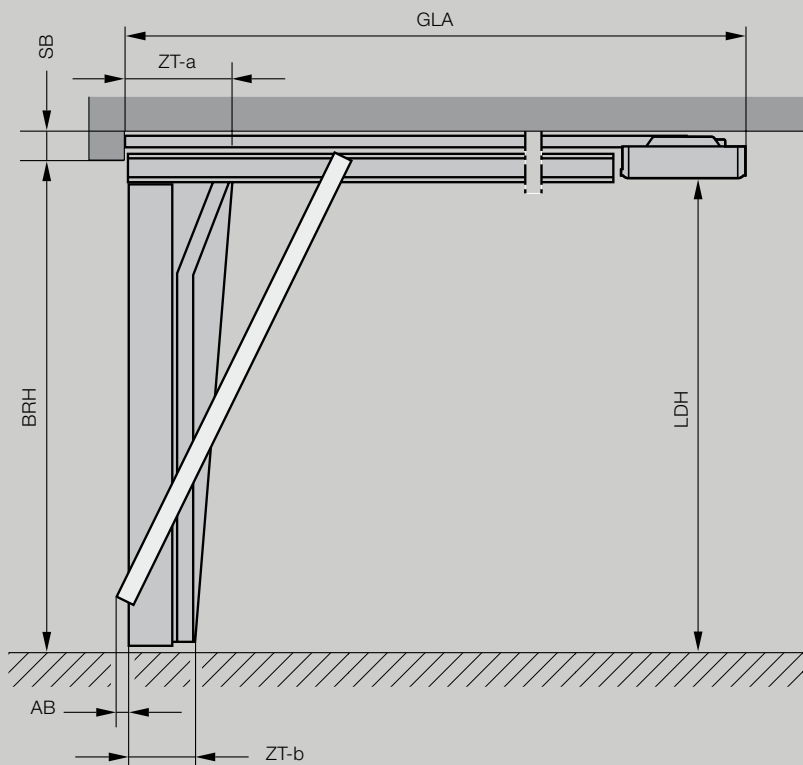

Horizontal view ET 500

Fitting behind the opening

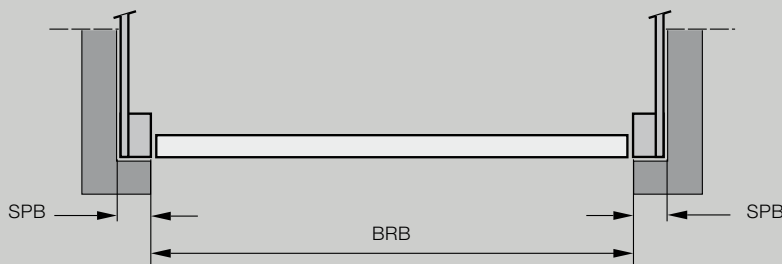

Explanations

- SB Required headroom
- LH Clear opening height
- LB Clear opening width
- LDH Clear passage height
- LDB Clear passage width
- SPB Side space requirement
- BRH Nominal height (ordering size)
- BRB Nominal width (ordering size)
- ZT Fitting depth
- AB Swinging range

Overall length with operator GLA

SupraMatic HT		
BRH 2000 – 2250		3200
BRH 2255 – 2500		3450
BRH 2505 – 3000		4125
ITO 400 FU		
BRH 2000 – 2700		3840
BRH 2705 – 3000		4840

Required headroom SB*

SupraMatic HT / ITO 400 FU		
Fitting behind the opening		100 / 120
with wicket door		100 / 120
with surface-mounted infill		
y = thickness of surface-mounted infill		y + 100 / y + 120
Fitting in the opening		120 / 140
with wicket door		120 / 140
with surface-mounted infill		
y = thickness of surface-mounted infill		y + 120 / y + 140

Clear opening height LH

BRH = LH	2000 – 3000
----------	-------------

Clear passage height LDH

BRB < 4500	= BRH – 20
BRB ≥ 4500	= BRH – 60
with wicket door	= BRH – 70

Side space requirement SPB*

ET 500 L	At least 140
ET 500 S	At least 250

Clear opening width LB

BRB = LB	2250 – 6000
----------	-------------

Swinging range AB with flush-fitting installation

ET 500 L	35
ET 500 S	40

Fitting depth ZT-a/ZT-b

ET 500 L	450 / 295
ET 500 S	400 / 245

Note

For further information, please see the fitting data or contact your Hörmann partner.

* An optional subframe is available for fitting situations without a lintel and / or sideroom.

Vertical view ST 500

Fitting behind the opening

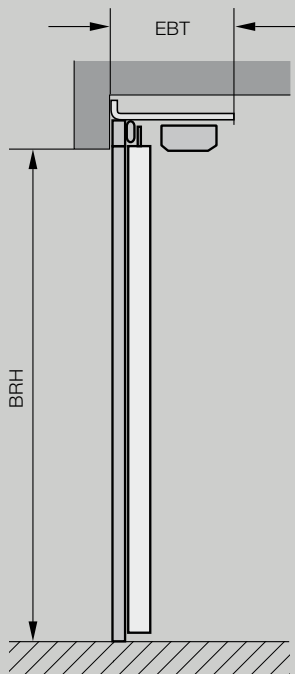

Explanations

EBT	Fitting depth
LH	Clear opening height
LB	Clear opening width
LDH	Clear passage height
LDB	Clear passage width
SPB	Side space requirement
BRH	Nominal height (ordering size)
BRB	Nominal width (ordering size)

Fitting depth EBT

Approx. 450

Nominal height BRH = clear opening height LH

BRH 2000 – 3000

Side space requirement SPB

$SPB = BRB + 310$

Nominal size width BRB = clear opening width LB

BRB 2250 – 6000

Clear passage height LDH

$LDH = BRH$

Clear passage width LDB

$LDB = BRB - 60$

(The clear passage may vary depending on the fitting situation)

Note

For further information, please see the fitting data or contact your Hörmann partner.

Horizontal view ST 500

Fitting behind the opening

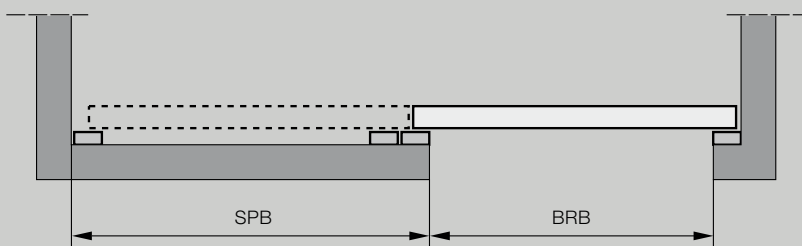

Wicket door vertical views

Non-protruding up-and-over door
ET 500 with wicket door

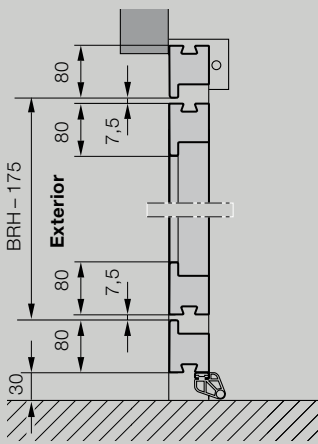

Sliding door ST 500
with wicket door

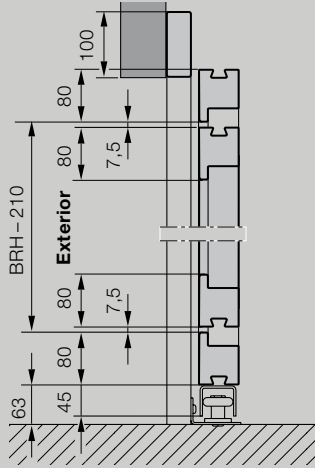

Explanations

- LDH Clear passage height
- LDB Clear passage width
- RAM Overall frame dimension (ordering size)
- BRH Nominal size height
- BRB Nominal size width

Clear passage height LDH

- ET 500 BRH – 175
- ST 500 BRH – 210

Clear passage width LDB

At least 900

Note

For further information, please see the fitting data or contact your Hörmann partner.

Wicket door horizontal views

Non-protruding up-and-over door
ET 500 with wicket door

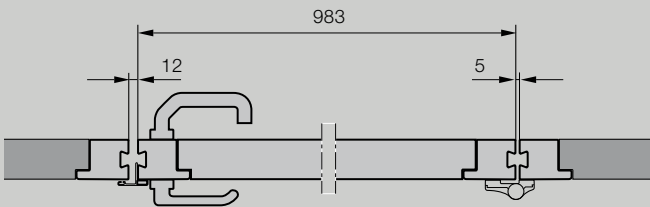

Sliding door ST 500
with wicket door

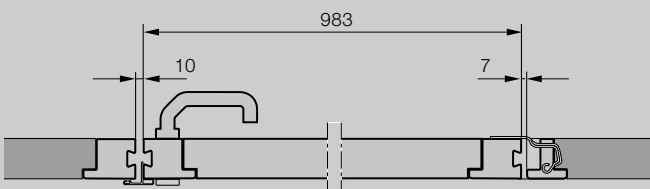

Side door vertical views

Fitting behind the opening

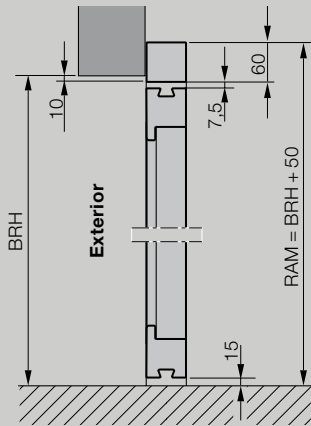

Fitting in the opening

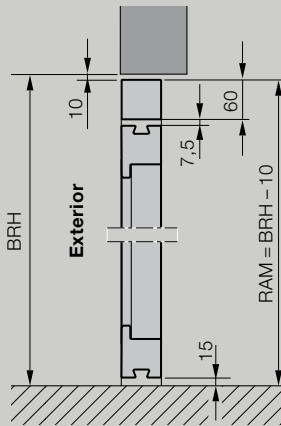

Explanations

- LDH Clear passage height
- LDB Clear passage width
- RAM Overall frame dimension (ordering size)
- BRH Nominal size height
- BRB Nominal size width

Clear passage height LDH

Max. 2440

Clear passage width LDB

Max. 1363, is reduced if the opening angle < 180°

Note

For further information, please see the fitting data or contact your Hörmann partner.

Side door horizontal views

Fitting behind the opening

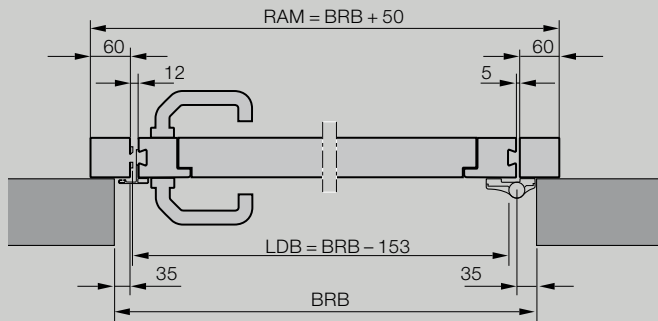

Fitting in the opening

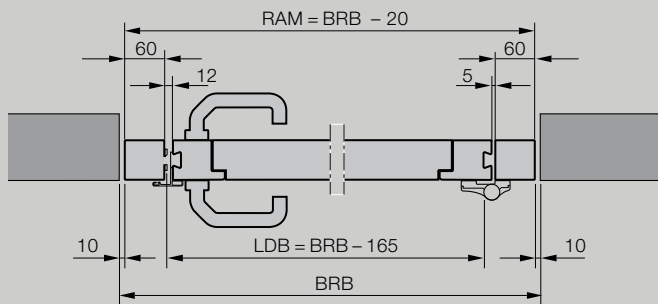

Experience Hörmann quality in new construction and modernisation

Hörmann provides an excellent basis for comprehensive planning. Carefully matched solutions offer you the very best in perfectly designed products for every area.

- **Garage doors**

Optimally match your personal architectural style: up-and-over or sectional doors made of steel or timber.

- **Door operators**

Enjoy extra convenience and break-in-resistant security with Hörmann operators for garage doors and entrance gates. You can profit from the convenience of Hörmann door operators in your residential space as well.

- **Entrance doors**

Our comprehensive entrance door ranges include models that fit almost every need and requirement.

- **Steel doors**

Sturdy doors for your entire home, from basement to roof.

- **Frames**

Choose from our comprehensive range of products for new construction, expansion and modernisation.



Garage doors and entrance gate operators



ThermoPro entrance door



Steel doors

Hörmann: Quality without Compromise



Hörmann KG Amshausen, Germany



Hörmann KG Antriebstechnik, Germany



Hörmann KG Brandis, Germany



Hörmann KG Brockhagen, Germany



Hörmann KG Dissen, Germany



Hörmann KG Eckelhausen, Germany



Hörmann KG Freisen, Germany



Hörmann KG Ichttershausen, Germany



Hörmann KG Werne, Germany



Hörmann Alkmaar B.V., Netherlands



Hörmann Legnica Sp. z o.o., Poland



Hörmann Beijing, China



Hörmann Tianjin, China



Hörmann LLC, Montgomery IL, USA



Hörmann Flexon LLC, Burgettstown PA, USA



Shakti Hörmann Pvt. Ltd., India

Hörmann is the only manufacturer worldwide that offers you a complete range of all major building products from one source. We manufacture in highly-specialised factories using the latest production technologies. The close-meshed network of sales and service companies throughout Europe, and activities in the USA and Asia, make Hörmann your strong partner for first-class building products, offering “Quality without Compromise”.

GARAGE DOORS
OPERATORS
INDUSTRIAL DOORS
LOADING EQUIPMENT
HINGED DOORS
DOOR FRAMES