



Series 2000 Entrance Door Price List

03.04.2017

HÖRMANN

Hörmann (UK) Limited

Gee Road

Coalville

Leicestershire

LE67 4JW

Phone: 01530 513000

Fax: 01530 513001

info@hormann.co.uk





Contents

Thermo46 entrance doors		From page
TPS		
	TPS product description and technical presentation	2
	TPS entrance doors	6
	Accessories for TPS entrance doors	9
	Side elements and transom lights	18
	Overview of panels / glass for side elements	19
Thermo65 entrance doors		
From page		
THP		
	THP product description and technical presentation	20
	THP entrance doors	26
	THP entrance door accessories	30
	Side elements and transom lights	40
	Overview of glass for side elements	41
Steel security doors		From page
	KSi Thermo	42
Steel multi purpose doors		
	MZ Thermo46	43
	Accessories for MZ Thermo46	44
	MZ Thermo65	45
	Accessories for MZ Thermo65	46

For further information on Thermo 46 and Thermo 65 entrance doors see our brochure.

Thermo46 Entrance Doors

Entrance door programme

Product description



Product description		Thermo46 – steel TPS															
		010	015	515	020	025	030	040	100	200	400	700	750	900			
Door leaf structure																	
Smooth sheet	“Modern”	●			●		●	●				●	●	●			
Ribbed sheet	“Modern”		●	●		●											
Panelled sheet	“Classic”								●	●	●						
Door leaf thickness		46 mm thick															
Fully foamed With thermal break Exterior and interior overlapping the leaf		●	●	●	●	●	●	●	●	●	●	●	●	●			
Size ranges (see also page 4)																	
Standard sizes (overall frame size)		1000 × 2100 mm and 1100 × 2100 mm															
Special sizes (overall frame size)		“Modern” type A					“Classic”				“Modern” type B						
	700 – 1250 mm Width 1875 – 2250 mm Height	●			●		●	●				●	●				
	800 – 1250 mm Width 1875 – 2250 mm Height													●			
// NEW	875 – 1250 mm Width 1875 – 2250 mm Height		●	●		●											
	875 – 1100 mm Width 1875 – 2186 mm Height								●		●						
	875 – 1100 mm Width 1990 – 2186 mm Height									●							
Surface																	
Standard		●	●	●	●	●	●	●	●	●	●	●	●	●			
		<ul style="list-style-type: none"> Painted in Traffic white on both sides, based on RAL 9016 Silk matt, gloss level 35 – 40 % 															
Colour		●	●	●	●	●	●	●	●	●	●	●	●	●			
		<ul style="list-style-type: none"> 16 preferred colours Painted on both sides, based on the RAL colour chart Silk matt, gloss level 35 – 40 % 															
		RAL 1015 Light ivory			RAL 6005 Moss green				RAL 8028 Terra brown								
		RAL 3000 Flame red			RAL 7016 Anthracite grey				RAL 9001 Cream								
		RAL 3003 Ruby red			RAL 7035 Light grey				RAL 9002 Grey white								
		RAL 3004 Purple red			RAL 7040 Window grey				RAL 9006 White aluminium								
		RAL 5010 Gentian blue			RAL 8003 Clay brown				RAL 9007 Grey aluminium								
		RAL 5014 Pigeon blue															
Decor	Golden Oak	●	●	●	●	●	●	●				●	●	●			
Foil-coating, both sides	Dark Oak	●	●	●	●	●	●	●				●	●	●			
	Night Oak	●	●	●	●	●	●	●				●	●	●			
	Winchester Oak	●	●	●	●	●	●	●				●	●	●			
	Titan Metallic CH 703	●	●	●	●	●	●	●				●	●	●			
Seals																	
4-sided, double EPDM seals, black, with continuous lip seal in the bottom sheet, additional EPDM form parts in both bottom corners for additional sealing, incl. brush seal in the frame		●	●	●	●	●	●	●	●	●	●	●	●	●			
Lock																	
Multiple-point locking with main lock (with soft-lock latch) and 2 bolts, pivoting / hook bolt combination		●	●	●	●	●	●	●	●	●	●	●	●	●			
Electric strikes																	
Electric strike with day catch (separate)		○	○	○	○	○	○	○	○	○	○	○	○	○			
Security bolts																	
3x anti-leverage guard		●	●	●	●	●	●	●	●	●	●	●	●	●			
Thermal insulation value (in W/(m²-K))																	
▶ Dependent on the size and frame type		For a product description, see page 6 to 8															

- Standard
- Optional

Thermo46 Entrance Doors

Entrance door programme

Product description



Product description		Thermo46 – steel TPS												
		010	015	515	020	025	030	040	100	200	400	700	750	900
Version in RC 2														
Attack side = opposite hinge side														
RC 2 with aluminium frame, hook bolt lock, profile cylinder with drilling and pull-off protection as well as security card		○	○	○						○				
RC 2 with aluminium frame, hook bolt lock, profile cylinder with drilling and pull-off protection as well as security card and safety glass A3 (P4A)											○	○	○	
Size ranges														
Size ranges in which an RC 2 version is possible	832 – 1250 mm Width 1875 – 2250 mm Height	○										○	○	○
	875 – 1250 mm Width 1875 – 2250 mm Height		○	○										
	875 – 1100 mm Width 1875 – 2186 mm Height								○					
Fittings														
Hinges														
– 3 two-part guide rollers (180 mm), 3-way adjustable with cover caps (stainless steel look)		●	●	●	●	●	●	●	●	●	●	●	●	●
Door handle (exterior)														
– Exterior handle HB 14-2, brushed stainless steel		●	●	●	●	●	●	●	●	●	●	○	○	○
– Exterior handle HB 38-2, brushed stainless steel		○	○	○	○	○	○	○	○	○	○	●	●	●
Door handle (interior)														
– Stainless steel lever handle		●	●	●	●	●	●	●	●	●	●	●	●	●
Rose escutcheon (exterior and interior)														
– Oval stainless-steel profile cylinder rose escutcheons		●	●	●	●	●	●	●	●	●	●	●	●	●
Profile cylinders														
– Cylinder length 35.5 × 27.5 mm with 5 keys		●	●	●	●	●	●	●	●	●	●	●	●	●
Glazing frame														
• Round-style plastic, clipped					●	●	●	●						
• Profile-style plastic, clipped														
– With surface-mounted plastic rails										●	●			
• Stainless steel, bonded												●	●	●
Glazing														
• Double-pane insulated glazing, 26 mm thick, exterior laminated safety glass – interior Mastercarré single-pane safety glass					●	●	●							
• Double-pane insulated glazing, 26 mm thick, exterior laminated safety glass – interior single-pane safety ornamental glass 504 with fine structure								●						
• Double-pane insulated glazing, 24 mm thick, exterior laminated safety glass – interior single-pane safety cathedral glass with small hammered finish										●				
• Double-pane insulated glazing, 26 mm thick, exterior laminated safety glass – interior single-pane safety cathedral glass with small hammered finish											●			
• Triple-pane insulated glazing, 44 mm thick, exterior laminated safety glass – float sand-blasted with clear stripes – interior single-pane safety glass												●	●	●
Frames														
• Aluminium block frame with aluminium / plastic threshold, with thermal break, colour matching the door leaf		●	●	●	●	●	●	●	●	●	●	●	●	●
Side Element / Transom Light														
• For doors opening inwards		○	○	○	○	○	○	○	○	○	○	○	○	○

- Standard
- Optional

Note:

For doors with dark surfaces, the material expansion is particularly high. Therefore, please check the location of the door in the building in your consultation meeting. This will ensure trouble-free door operation.

Thermo46 Entrance Doors

Entrance door programme

Technical presentation of door set



TPS entrance doors with aluminium frame (profile A1 shown in the drawing)

Standard sizes		
Overall frame dimension Ordering size	Structural opening	Clear frame dimensions
1000 x 2100	1020 x 2110	872 x 2016
1100 x 2100	1120 x 2110	972 x 2016

Special sizes		
TPS Styles	Overall frame dimension	
	Width	Height
010/020/030/040/ 700/750	700 - 1250	1875 - 2250
900	800 - 1250	1875 - 2250
015/025/515	875 - 1250	1875 - 2250
100/400	875 - 1100	1875 - 2186
200	875 - 1100	1990 - 2186

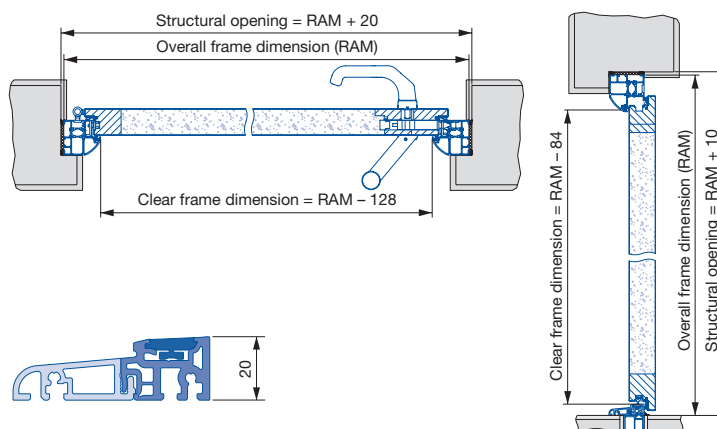

Wall connections for frames

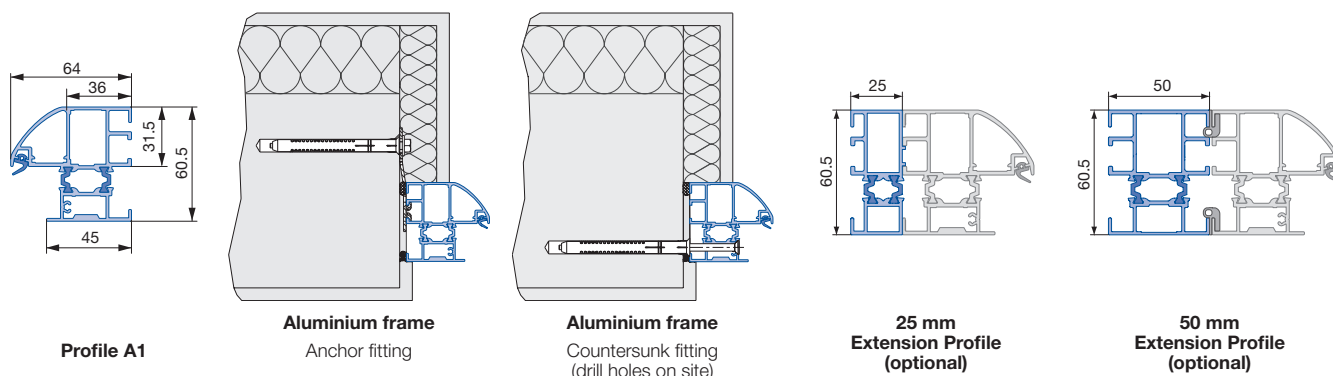

Wall connections for frames

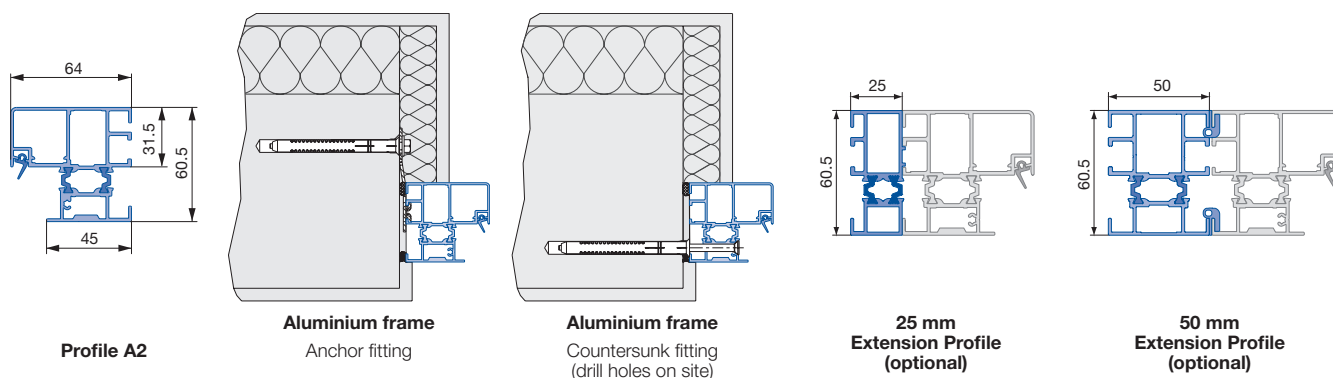

Thermo46 entrance doors

Entrance door programme

Technical presentation of door set with side element / transom light



TPS entrance doors with side element / transom light

Standard sizes – Side element		
TPS Styles	Overall frame dimension	
	Width	Height
010/015/515/020/025/030/040/700/750/900	400	2100
100/200/400	450	2100

Special sizes – Side element		
TPS Styles	Overall frame dimension	
	Width	Height
010/015/515/040	See pages 18 and 19	
020/025/030/700/750/900		
100/200/400		

Size range – Transom light		
TPS Styles	Overall frame dimension	
	Width	Height
All styles	See page 18	

Clear view		
	Width	Height
Side element	RAM side element – 116	RAM side element – 138
Transom light	RAM transom light – 116	RAM transom light – 116

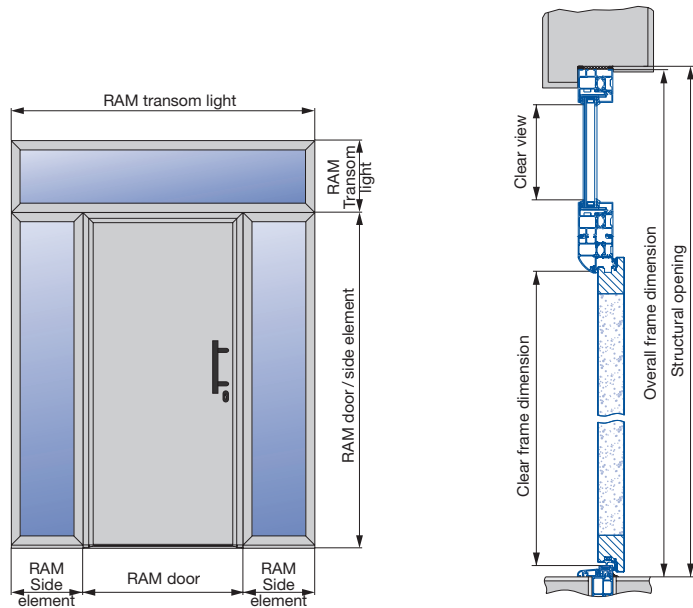
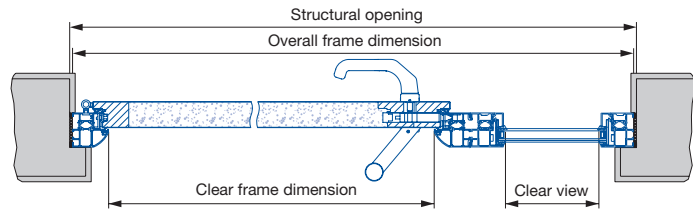
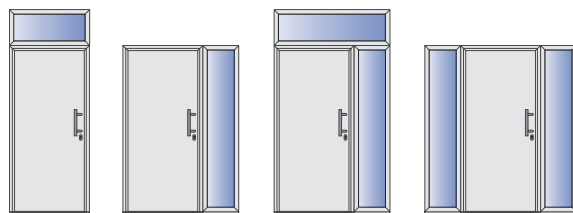

Clear view for styles with glazing

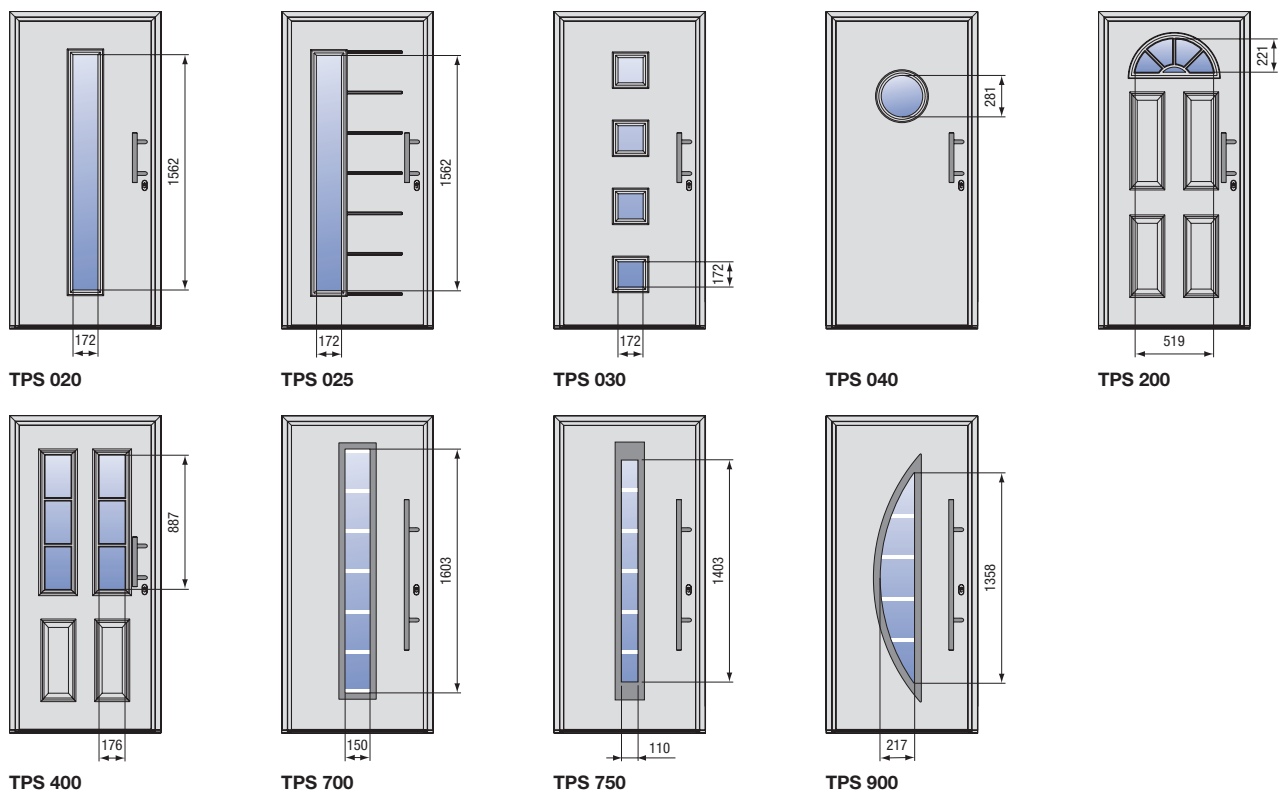

Thermo46 Entrance Doors – Steel

Entrance door programme



For a product description, see from page 2

- Steel door leaf overlapping the frame, with thermal break, exterior and interior in same colour
- Aluminium frame
- Multiple-point lock

Colour 16 preferred colours (see page 2)

Decor Golden Oak, Dark Oak, Night Oak, Winchester Oak and Titan Metallic CH 703

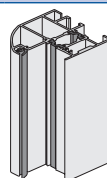

Profile A1

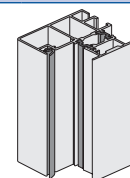

Profile A2

View	Style description	Size (RAM)	RAL 9016	Colour	Decor	RAL 9016	Colour	Decor
	Style TPS 010 <ul style="list-style-type: none"> • Smooth sheet • Handle HB 14-2 	1000 × 2100	1009	1216	1255	1009	1216	1255
		1100 × 2100						
		From 700 × 1875 Up to 1250 × 2250	1339	1546	1585	1339	1546	1585
▶ U _D -value for size 1230 × 2180 mm: 1.1 W/(m ² ·K)								
	Style TPS 015 <ul style="list-style-type: none"> • Ribbed sheet with 7 ribs • Handle HB 14-2 	1000 × 2100	1084	1291	1330	1084	1291	1330
		1100 × 2100						
		From 875 × 1875 Up to 1250 × 2250	1413	1620	1659	1413	1620	1659
▶ U _D -value for size 1230 × 2180 mm: 1.1 W/(m ² ·K)								
	Style TPS 515 <ul style="list-style-type: none"> • Ribbed sheet with 3 ribs • Handle HB 14-2 	1000 × 2100	1084	1291	1330	1084	1291	1330
		1100 × 2100						
		From 875 × 1875 Up to 1250 × 2250	1413	1620	1659	1413	1620	1659
▶ U _D -value for size 1230 × 2180 mm: 1.1 W/(m ² ·K)								
	Style TPS 020 <ul style="list-style-type: none"> • Smooth sheet • 2 panes of insulated glass, Mastercarré single-pane safety glass and clear laminated safety glass • Plastic glazing frame in door leaf colour (exception: decor surface finish*) • Handle HB 14-2 	1000 × 2100	1382	1833	1874	1382	1833	1874
		1100 × 2100						
		From 700 × 1875 Up to 1250 × 2250	1711	2162	2203	1711	2162	2203
▶ U _D -value for size 1230 × 2180 mm: 1.4 W/(m ² ·K)								
	Style TPS 025 <ul style="list-style-type: none"> • Ribbed sheet • 2 panes of insulated glass, Mastercarré single-pane safety glass and clear laminated safety glass • Plastic glazing frame in door leaf colour (exception: decor surface finish*) • Handle HB 14-2 	1000 × 2100	1457	1908	1949	1457	1908	1949
		1100 × 2100						
		From 875 × 1875 Up to 1250 × 2250	1786	2237	2278	1786	2237	2278
▶ U _D -value for size 1230 × 2180 mm: 1.4 W/(m ² ·K)								

* For decor door surface finishes, the plastic glazing frames are coated in a colour matching the decor.

Thermo46 Entrance Doors – Steel

Entrance door programme



For a product description, see from page 2

- Steel door leaf overlapping the frame, with thermal break, exterior and interior in same colour
- Aluminium frame
- Multiple-point lock

Colour 16 preferred colours (see page 2)
Decor Golden Oak, Dark Oak, Night Oak, Winchester Oak and Titan Metallic CH 703

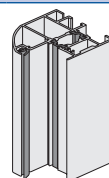

Profile A1

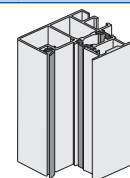

Profile A2

View	Style description	Size (RAM)	RAL 9016	Colour	Decor	RAL 9016	Colour	Decor
	Style TPS 030 <ul style="list-style-type: none"> • Smooth sheet • 2 panes of insulated glass, Mastercarré single-pane safety glass and clear laminated safety glass • Plastic glazing frame in door leaf colour (exception: decor surface finish*) • Handle HB 14-2 	1000 × 2100	1460	1911	1952	1460	1911	1952
		1100 × 2100						
		From 700 × 1875 Up to 1250 × 2250	1789	2240	2281	1789	2240	2281
▶ U _D -value for size 1230 × 2180 mm: 1.3 W/(m ² ·K)								
	Style TPS 040 <ul style="list-style-type: none"> • Smooth sheet • 2 panes of insulated glass, single-pane safety ornamental glass 504 with fine structure and clear laminated safety glass • Plastic glazing frame in door leaf colour (exception: decor surface finish*) • Handle HB 14-2 	1000 × 2100	1354	1805	1846	1354	1805	1846
		1100 × 2100						
		From 700 × 1875 Up to 1250 × 2250	1683	2134	2175	1683	2134	2175
▶ U _D -value for size 1230 × 2180 mm: 1.2 W/(m ² ·K)								
	Style TPS 100 <ul style="list-style-type: none"> • Panelled sheet • Handle HB 14-2 	1000 × 2100	1037	1244	-	1037	1244	-
		1100 × 2100						
		From 875 × 1875 Up to 1100 × 2186	1366	1573	-	1366	1573	-
▶ U _D -value for size 1230 × 2180 mm: 1.1 W/(m ² ·K)								
	Style TPS 200 <ul style="list-style-type: none"> • Panelled sheet • 2 panes of insulated glass, cathedral single-pane safety glass with small hammered finish and clear laminated safety glass • Plastic glazing frame with surface-mounted rails • Handle HB 14-2 	1000 × 2100	1142	1593	-	1142	1593	-
		1100 × 2100						
		From 875 × 1990 Up to 1100 × 2186	1471	1922	-	1471	1922	-
▶ U _D -value for size 1230 × 2180 mm: 1.2 W/(m ² ·K)								
	Style TPS 400 <ul style="list-style-type: none"> • Panelled sheet • 2 panes of insulated glass, cathedral single-pane safety glass with small hammered finish and clear laminated safety glass • Plastic glazing frame with surface-mounted rails • Handle HB 14-2 	1000 × 2100	1221	1672	-	1221	1672	-
		1100 × 2100						
		From 875 × 1875 Up to 1100 × 2186	1550	2001	-	1550	2001	-
▶ U _D -value for size 1230 × 2180 mm: 1.5 W/(m ² ·K)								

* For decor door surface finishes, the plastic glazing frames are coated in a colour matching the decor.

Thermo46 Entrance Doors – Steel

Entrance door programme



For a product description, see from page 2

- Steel door leaf overlapping the frame, with thermal break, exterior and interior in same colour
- Aluminium frame
- Multiple-point lock

Colour 16 preferred colours (see page 2)

Decor Golden Oak, Dark Oak, Night Oak, Winchester Oak and Titan Metallic CH 703

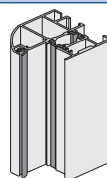

Profile A1

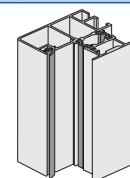

Profile A2

View	Style description	Size (RAM)	RAL 9016	Colour	Decor	RAL 9016	Colour	Decor
	Style TPS 700 <ul style="list-style-type: none"> • Smooth sheet • 3 panes of insulated glass, clear single-pane safety glass, sand-blasted float with clear horizontal stripes and clear laminated safety glass • Stainless steel glazing frame • Handle HB 38-2 	1000 × 2100	1805	2012	2051	1805	2012	2051
		1100 × 2100						
		From 700 × 1875 Up to 1250 × 2250	2134	2341	2380	2134	2341	2380
▶ U _D -value for size 1230 × 2180 mm: 1.3 W/(m ² ·K)								
	Style TPS 750 <ul style="list-style-type: none"> • Smooth sheet • 3 panes of insulated glass, clear single-pane safety glass, sand-blasted float with clear horizontal stripes and clear laminated safety glass • Stainless steel glazing frame • Handle HB 38-2 	1000 × 2100	1805	2012	2051	1805	2012	2051
		1100 × 2100						
		From 700 × 1875 Up to 1250 × 2250	2134	2341	2380	2134	2341	2380
▶ U _D -value for size 1230 × 2180 mm: 1.2 W/(m ² ·K)								
	Style TPS 900 <ul style="list-style-type: none"> • Smooth sheet • 3 panes of insulated glass, clear single-pane safety glass, sand-blasted float with clear horizontal stripes and clear laminated safety glass • Stainless steel glazing frame • Handle HB 38-2 	1000 × 2100	1968	2175	2214	1968	2175	2214
		1100 × 2100						
		From 800 × 1875 Up to 1250 × 2250	2297	2504	2543	2297	2504	2543
▶ U _D -value for size 1230 × 2180 mm: 1.2 W/(m ² ·K)								

Thermo46 entrance doors

Entrance door programme

Accessories



Exterior door handles (included in door price)				£
	<p>Handle HB 14-2</p> <ul style="list-style-type: none"> Brushed stainless steel Standard with styles TPS 010, TPS 015, TPS 020, TPS 025, TPS 030, TPS 040, TPS 100, TPS 200, TPS 400 and TPS 515 	<p>Surcharge for conversion to handle HB 14-2</p>		118
	<p>Handle HB 38-2</p> <ul style="list-style-type: none"> Brushed stainless steel Standard with styles TPS 700, TPS 750 and TPS 900 	<p>Surcharge for conversion to handle HB 38-2</p>		118
	<p>// NEW Handle HB 38-3</p> <ul style="list-style-type: none"> Brushed stainless steel 	<p>Surcharge for conversion to handle HB 38-3</p>		118
ES 0 fittings		Including profile cylinder with 5 keys	Surcharges	£
	Knob / lever	Stainless steel	Each	118
	Lever / lever	Stainless steel	Each	118
ES 1 fittings		Including profile cylinder with 5 keys	Surcharges	£
Note: ES 1 fittings are only possible from a RAM of 900 mm for style TPS 400.				
	Knob / lever	Stainless steel	Each	320
	Lever / lever	Stainless steel	Each	320

Thermo46 entrance doors

Entrance door programme

Accessories

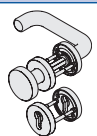
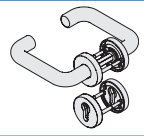
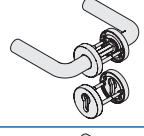
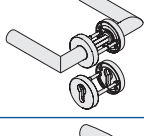
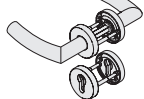

Rose escutcheons	Including profile cylinder with 5 keys		Surcharges	£
	// NEW Knob/lever handle, type D-110	Stainless steel	Each	118
	Lever handle/lever handle, type D-110	Stainless steel	Each	118
	// NEW Lever handle/lever handle, type D-210	Stainless steel	Each	118
	// NEW Lever handle/lever handle, type D-310	Stainless steel	Each	118
	// NEW Lever handle/lever handle, type D-510	Stainless steel	Each	118

Calculation example £

**Conversion
TPS 020 with HB 14-2
to
HB 38-2**



Style TPS 020 in RAL 9016 with profile A1 (standard size)	1382
+ Conversion from handle HB 14-2 to handle HB 38-2	118
= Total	1500

**Conversion
TPS 700 with HB 38-2
to
Fitting ES 1**

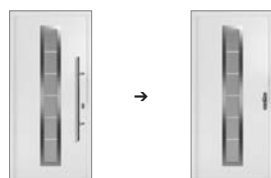

Style TPS 700 in RAL 9016 with profile A1 (standard size)	1805
+ Surcharge for ES 1 stainless steel knob/lever handle fitting	320
= Total	2125

Advanced handle and letter plate options for styles TPS 100, TPS 200 and TPS 400 £

Silver aluminium sleeved letter plate only TPS 100, TPS 200 and TPS 400 **42**

Accessories surcharge £

Prepared for letter drop
(TPS 010, 040, 100, 200, 400) per door **37**

Glazing separative horizontal rail in the side element (only in RAL 9016 and Colour)



Rail in the side element (not milled) per side element **197**

- Glazing separative horizontal rail

Rail in the side element (milled) per side element **233**

- glazing separative horizontal rail
- milled for installation of a letter plate from size ≥ 450 mm (width)

Thermo46 entrance doors

Entrance door programme

Accessories

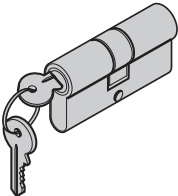

Profile cylinders				£
	Profile cylinder (35.5 + 27.5 mm) For HB 14-2 and HB 38-2 push bars	With 8 keys	Each	48
		With 10 keys	Each	56
	Profile cylinder (40.5 + 31.5 mm) For ES 0 fittings	With 5 keys	Each	34
		With 8 keys	Each	48
		With 10 keys	Each	56
	Profile cylinder (40.5 + 31.5 mm) with drilling and pull-off protection and security card For fittings ES 1 and push bar with security rose escutcheon ES 1	With 5 keys	Each	73
With 8 keys		Each	99	
With 10 keys		Each	117	
Profile cylinder, keys to pass, for push bar or fittings ES 0	With 5 keys	Each	34	
	With 8 keys	Each	48	
	With 10 keys	Each	56	
Note: No keys to pass for the profile cylinder from the fitting package				
Profile cylinder, keys to pass, with drilling and pull-off protection and security card for ES 1 fittings	With 5 keys	Each	73	
	With 8 keys	Each	99	
	With 10 keys	Each	117	
Note: No keys to pass for the profile cylinder from the fitting package				

Rose escutcheon				£
	Exterior oval rose escutcheon (screwed)			Each
				43

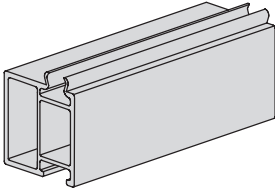
Profiles						£
	Bottom Spacer Profile	Length up to 1250 mm	Height	30 mm	Each	24
			Height	60 mm	Each	47
			Height	90 mm	Each	70
			Height	120 mm	Each	93
			Height	150 mm	Each	116
		Length up to 2250 mm	Height	30 mm	Each	39
			Height	60 mm	Each	77
			Height	90 mm	Each	116
			Height	120 mm	Each	154
			Height	150 mm	Each	192
		Length up to 3250 mm	Height	30 mm	Each	55
			Height	60 mm	Each	110
			Height	90 mm	Each	165
			Height	120 mm	Each	220
			Height	150 mm	Each	275

Thermo46 entrance doors

Entrance door programme

Accessories

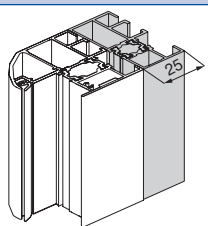
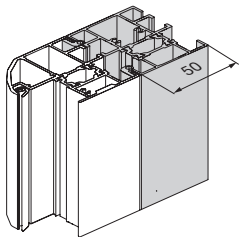
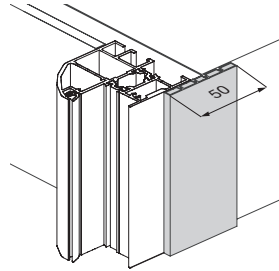
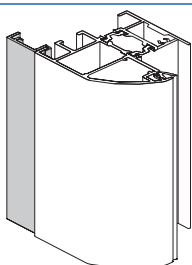

Profiles		£	
	Extension profile 25 mm Dimensions (W x D): 25 x 60.5 mm	RAL 9016	Per m 49
	Colour		Per m 58
	Golden Oak, Dark Oak, Night Oak, Winchester Oak, Titan Metallic CH 703		Per m 61
	Extension profile 50 mm Dimensions (W x D): 50 x 60.5 mm	RAL 9016	Per m 54
	Colour		Per m 63
	Golden Oak, Dark Oak, Night Oak, Winchester Oak, Titan Metallic CH 703		Per m 66
	Cover Profile Per package 2 x 2300 mm and 1 x 1300 mm Dimensions (W x D): 50 x 5 mm Profiles sufficient for a door without side elements / transom light	RAL 9016	Per box 110
	Golden Oak, Dark Oak, Night Oak, Winchester Oak,		Per box 147
	Titan Metallic CH 703		
	Supplementary profile (on three sides) Width 20 mm, mitred, incl. corner bracket and fitting screws	RAL 9016	Per door 226
	Colour		Per door 285
	Golden Oak, Dark Oak, Titan Metallic CH 703		Per door 294

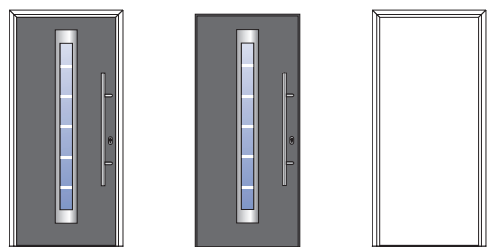
Door leaf and frame in different colours / surfaces			
Colours of door leaf and frame differ			
Example	Door leaf	Frame	Price for entrance door with surface
	Anthracite grey	Traffic white	
	RAL 9016	Colour	Colour
	RAL 9016	Decor	Decor
	Colour	RAL 9016	Colour
	Colour	Decor	Decor
	Decor	RAL 9016	Decor
Decor	Colour	Decor	

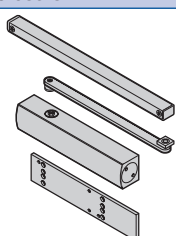

Door Closers		£	
	Door leaf prepared for overhead door closer (reinforcement in door leaf)	Each	28
	Overhead door closer HDC 35 for fitting on the hinge side For Thermo46 entrance doors with aluminium frame, profile A1 or A2	Each	161
	Overhead door closer HDC 35 for fitting on the opposite hinge side For Thermo46 entrance doors with aluminium frame, profile A2	Each	161
	Mechanical hold-open device	Each	61

Thermo46 entrance doors

Entrance door programme

Accessories

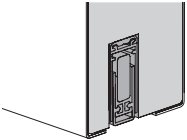
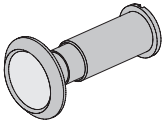
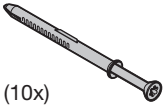
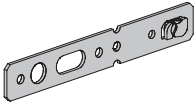
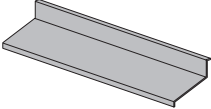
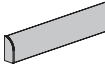
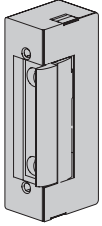
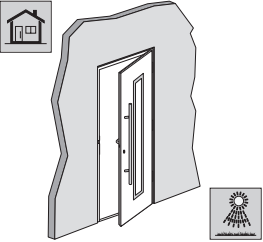

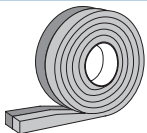
Retractable bottom seal		£
	Retractable bottom seal (Frame without threshold)	Each 259
Note: The performance characteristics thermal insulation (U_D) and water-tightness under heavy rain are limited!		
Accessories		£
	Spyhole (fitted) (only for TPS 010, TPS 015, TPS 100, TPS 200, TPS 400 and TPS 515)	Each 47
	Fitting set 10 x screws and 10 x plugs	Per set 21
	Screw-in anchor set Length 280 mm (8 x anchors)	Per set 27
	Rain canopy Anodised aluminium	Each 21
	Door drip	RAL 9016 Traffic white Each 32
		Stainless steel look Each 48
	Electric strike with day catch (separate)	Each 75
	Door set opening outwards (all approved characteristics will no longer apply!)	Per door 70
	Stainless steel cleaner and care product (150 ml)	Each 30
	Pre-compressed sealing strip (56 mm wide) for groove widths from 6 – 15 mm 5.90 m roll (approved for RAL fitting)	Per roll 81

Thermo46 entrance doors







Entrance door programme

Accessories









Entrance door in RC 2 version (for a product description, see page 2) £

Attack side = opposite hinge side

				Package HB 14-2 with security rose escutcheon	Stainless steel	Per door	252
				ES 1 fittings	Knob / lever	Stainless steel	Per door 320
					Lever / lever	Stainless steel	Per door 320
				Package HB 38-2 with security rose escutcheon and safety glass A3 (P4A)	Stainless steel	Per door	379
				Fittings ES 1 and safety glass A3 (P4A)	Knob / lever	Stainless steel	Per door 447
					Lever / lever	Stainless steel	Per door 447

Approved size range for RC 2 version for each style

							
	TPS 010	TPS 700	TPS 750	TPS 900	TPS 100	TPS 015	TPS 515
Width	832 × 1250				875 × 1100	875 × 1250	
Height	1875 × 2250				1875 × 2186	1875 × 2250	

Example for calculating an entrance door in an RC 2 version £

<p>Conversion TPS 700 with HB 38-2 to Package HB 38-2 with security rose escutcheon</p>		→		
				Style TPS 700 in RAL 9016 with profile A1 (standard size) 1805
				+ Conversion for package HB 38-2 with security rose escutcheon 379
				= Total 2184

Secured By Design option £



Secured by Design in conjunction with the Association of Chief Police Officers, is a security upgrade to help combat crime. The fully accredited door will come supplied with a high security cylinder complete with registration card and 3 security keys.

Available on styles 100, 700, 900, 010, 030, 040 and 015







106

Thermo46 entrance doors

Entrance door programme

Accessories



Embellishments in stainless steel look for style THP 010 (on the exterior)				Surcharge	£
	View 451	// NEW Stainless steel frame Overall dimension 240 x 240 mm Inside dimension 160 x 160 mm	Style TPS 010	Per door	223
	View 454	// NEW Stainless steel frame Overall dimension 145 x 145 mm	Style TPS 010	Per door	223
	View 457	// NEW Curved stainless steel frame	Style TPS 010	Per door	223
	View 459	// NEW Stainless steel rings Overall dimension Ø 240 mm Inside dimension Ø 160 mm	Style TPS 010	Per door	223
	View 460	// NEW Stainless steel frame over entire leaf height	Style TPS 010	Per door	223
	View 461	// NEW 3 parallel stainless steel strips over the entire leaf height	Style TPS 010	Per door	223

Thermo46 entrance doors

Entrance door programme

Accessories



Embellishments in stainless steel look (on the exterior) £

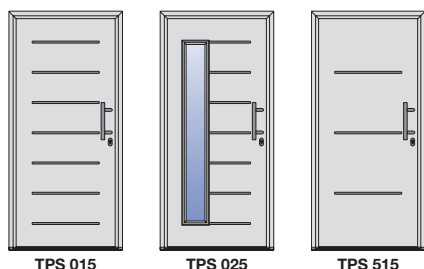

Embellishment in stainless steel look view 400

- Inlay length 577 mm per rib for styles TPS 015 and 515
- Inlay length 351 mm per rib for style TPS 025

Style TPS 015	Per door	174
Style TPS 025	Per door	174
Style TPS 515	Per door	116

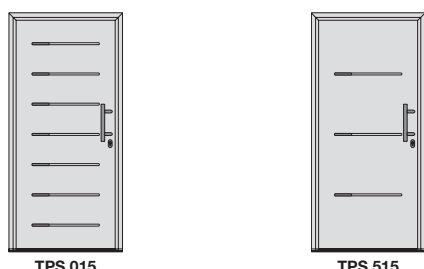

Embellishment in stainless steel look view 401
Inlay length 118 mm per rib

Style TPS 015	Per door	174
Style TPS 515	Per door	116

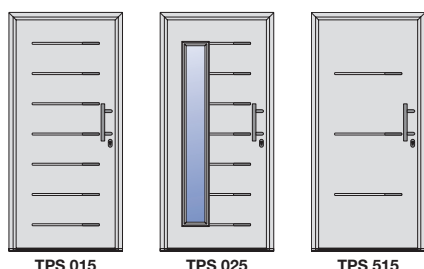

Embellishment in stainless steel look view 402
Inlay length 118 mm per rib

Style TPS 015	Per door	174
Style TPS 025	Per door	174
Style TPS 515	Per door	116

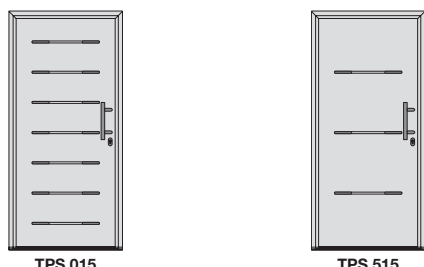

Embellishment in stainless steel look view 403
Inlay length 2 x 118 mm per rib

Style TPS 015	Per door	174
Style TPS 515	Per door	116

Stainless steel bottom sheet (on the exterior) £



Stainless steel bottom sheet (separate)

- Bottom sheet height 110 mm
- Size range of heights for style

Style	Height (RAM)	Per door	164
010 / 040	1875 – 2250 mm		
015 / 020 / 025 / 030 / 100 / 200 / 400 / 515 / 700 / 750 / 900	2050 – 2250 mm		

Notes and Sketches

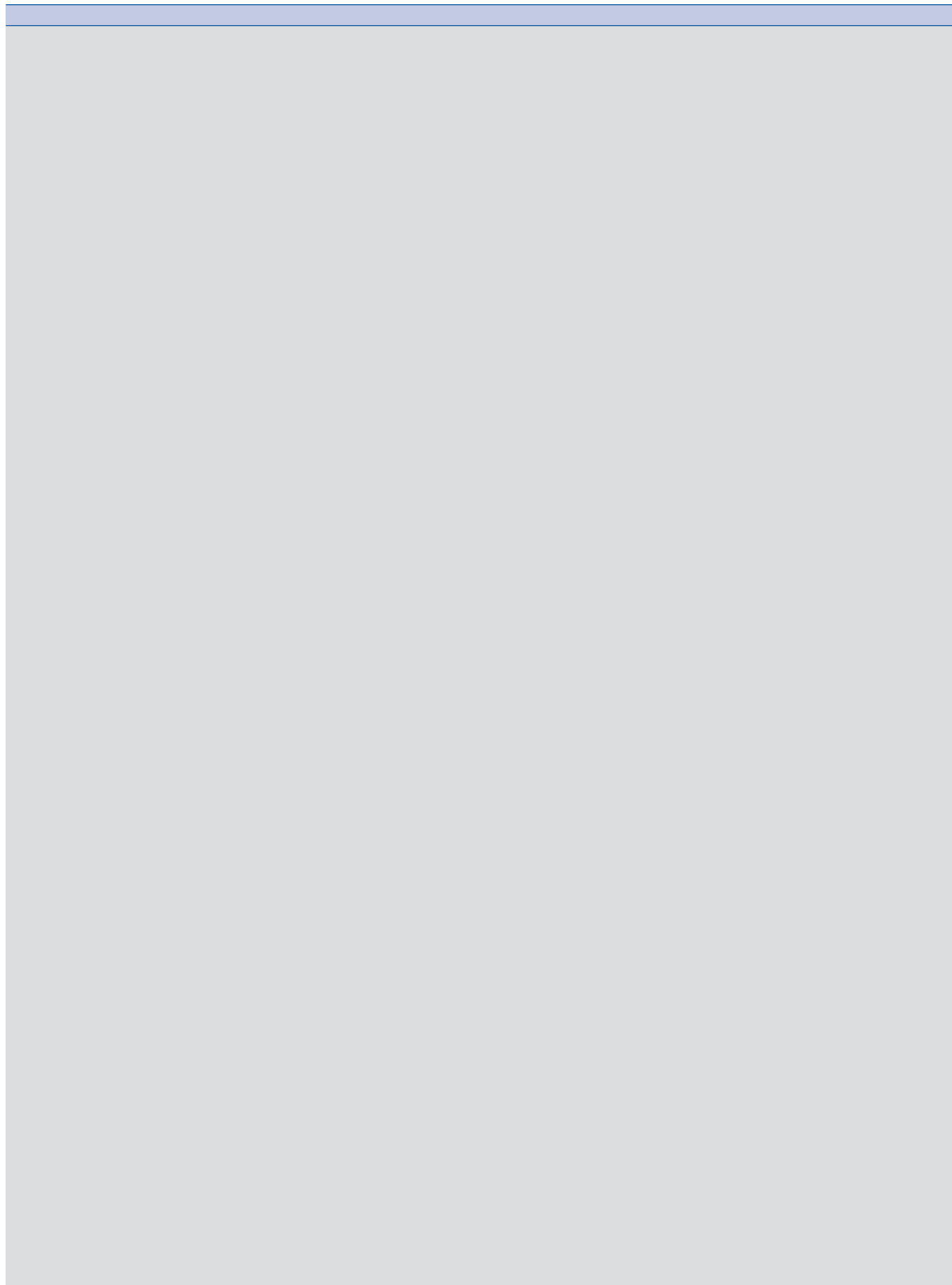

Thermo46 Entrance Doors

Entrance door programme

Side elements and transom lights



Side element

Fixed side element assembly

Standard size

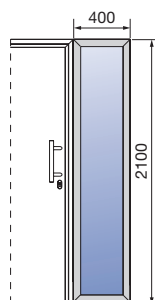

Ordering sizes RAM (mm) Width x Height	Glass	RAL 9016	Colour	Decor
400 x 2100	Mastercarré	696	809	845
	Clear glass	696	809	845
	Sand-blasted float	696	809	845
	Ornamental glass 504	696	809	845
	Cathedral glass	696	809	845
	Sand-blasted float with clear stripes	1173	1286	1322

Side element

Fixed side element assembly

Special sizes

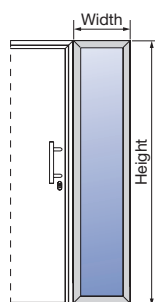

Ordering sizes RAM up to (mm) Width x Height	Glass	RAL 9016	Colour	Decor
From 300 x 1875 to 500 x 2250	Clear glass, Mastercarré, ornamental glass 504, cathedral glass or sand- blasted float according to overview on page 19	866	978	1016
to 1000 x 2250 *		1034	1144	1182
From 300 x 1875 to 500 x 2250 to 1000 x 2250 *	Sand-blasted float with clear stripes according to overview on page 19	1469	1581	1618
		1636	1749	1785

* Only possible without transom light

Door set with side element does not have a statics function. Statics must be ensured by the building structure.

Side element

Fixed side element assembly for "Classic" styles

Special size

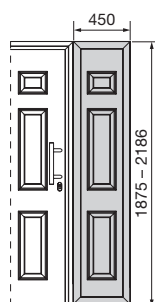

Ordering sizes RAM (mm) Width x Height	Panel / glass	RAL 9016	Colour
From 450 x 1875 to 450 x 2186	Panel <i>without</i> glass in accordance with the overview on page 19	603	712
From 450 x 1875 to 450 x 2186	Panel <i>with</i> glass in accordance with the overview on page 19	665	776

Transom light

Fixed transom light assembly

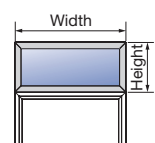





Ordering sizes RAM (mm) Width x Height	Glass	RAL 9016	Colour	Decor
From 700 x 300 to 1250 x 500	Clear glass, Mastercarré, ornamental glass 504, cathedral glass or sand- blasted float according to overview on page 19	654	767	807
Up to 2250 x 500		866	978	1016

Thermo46 Entrance Doors

Entrance door programme

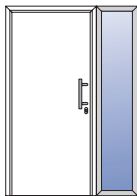
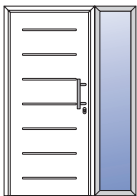
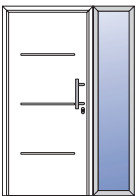
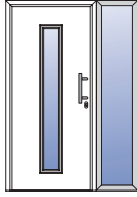
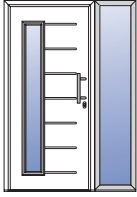
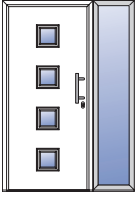
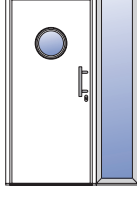
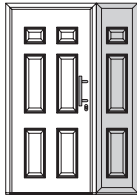
Overview of panels / glass for side elements

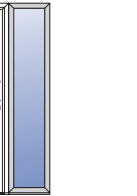

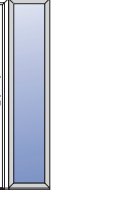
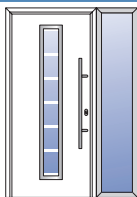
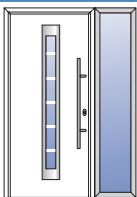
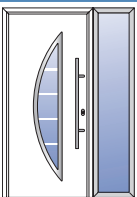
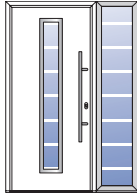
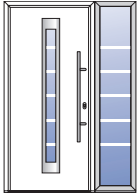
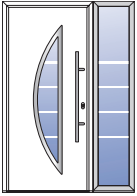
Infill / size range						
		Style	Glass	Size range		
				Side element	Transom light	
"Modern" type A				<ol style="list-style-type: none"> 1. Clear lamin. safety glass / Mastercarré single-pane safety glass 2. Clear lamin. safety glass / single-pane safety ornamental glass 504 3. Clear laminated safety glass / sand-blasted laminated safety glass (without clear stripes) 4. Clear laminated safety glass / clear laminated safety glass 	Width 300 – 1000 mm Height 1875 – 2250 mm	Width 700 – 2250 mm Height 300 – 500 mm
	TPS 010	TPS 015	TPS 515			
						
	TPS 020	TPS 025	TPS 030	<ol style="list-style-type: none"> 1. Clear lamin. safety glass / Mastercarré single-pane safety glass 2. Clear laminated safety glass / clear laminated safety glass 	Width 300 – 1000 mm Height 1990 – 2250 mm	Width 700 – 2250 mm Height 300 – 500 mm
				<ol style="list-style-type: none"> 1. Clear lamin. safety glass / single-pane safety ornamental glass 504 2. Clear laminated safety glass / clear laminated safety glass 	Width 300 – 1000 mm Height 1875 – 2250 mm	Width 700 – 2250 mm Height 300 – 500 mm
	TPS 040					
"Classic"				<ol style="list-style-type: none"> 1. Element with 3 panels 2. Clear laminated safety glass / clear laminated safety glass 3. Clear lamin. safety glass / single-pane safety cathedral glass 	Width Panel: 450 mm Glass: 300 – 1000 mm Height 1875 – 2186 mm	Width 875 – 2000 mm Height 300 – 500 mm
	TPS 100	TPS 200				
				<ol style="list-style-type: none"> 1. Element with 1 panel and glazing cut-out with clear laminated safety glass / single-pane safety cathedral glass 2. Clear laminated safety glass / clear laminated safety glass 3. Clear lamin. safety glass / single-pane safety cathedral glass 	Width Panel: 450 mm Glass: 300 – 1000 mm Height 1875 – 2186 mm	Width 875 – 2000 mm Height 300 – 500 mm
		TPS 400				
"Modern" type B				<ol style="list-style-type: none"> 1. Clear laminated safety glass / sand-blasted laminated safety glass (without clear stripes) 2. Clear laminated safety glass / clear laminated safety glass 3. Clear laminated safety glass / sand-blasted laminated safety glass with clear stripes (only in side element) 	Width 300 – 1000 mm Height 1875 – 2250 mm	Width 700 – 2250 mm Height 300 – 500 mm
	TPS 700	TPS 750	TPS 900			
						
	TPS 700	TPS 750	TPS 900			

Thermo65 Entrance Doors

Entrance door programme

Product description



Product description		Thermo65 – steel THP																															
		//NEW																															
		010	015	515	100	410	430	450	600	700	750	800	810	850	900																		
Door leaf structure																																	
Smooth sheet		●							●	●	●	●	●	●	●																		
Ribbed sheet			●	●																													
Panelled sheet					●	●	●	●																									
Door leaf thickness		65 mm thick																															
Fully foamed With thermal break Exterior and interior overlapping the leaf		●	●	●	●	●	●	●	●	●	●	●	●	●	●																		
Size ranges (see also page 22)																																	
Standard sizes (overall frame size)		1000 × 2100 mm and 1100 × 2100 mm																															
700–1250 mm Width 1875–2250 mm Height		●							●	●	●	●	●																				
Special sizes (overall frame size) //NEW																																	
800–1250 mm Width 1875–2250 mm Height														●	●																		
875–1250 mm Width 1875–2250 mm Height			●	●																													
875–1100 mm Width 1875–2186 mm Height					●	●	●	●																									
Surface																																	
Note: For doors with dark surfaces, the material expansion is particularly high. Therefore, please check the location of the door in the building in your consultation meeting. This will ensure trouble-free door operation.																																	
Standard		●	●	●	●	●	●	●	●	●	●	●	●	●	●																		
		<ul style="list-style-type: none"> Painted in Traffic white on both sides, based on RAL 9016 Silk matt, gloss level 35–40 % 																															
Colour		●	●	●	●				●	●	●	●	●	●	●																		
		<ul style="list-style-type: none"> 16 preferred colours Painted on both sides, based on the RAL colour chart Silk matt, gloss level 35–40 % 																															
		<table border="0"> <tr> <td>RAL 1015 Light ivory</td> <td>RAL 6005 Moss green</td> <td>RAL 8028 Terra brown</td> </tr> <tr> <td>RAL 3000 Flame red</td> <td>RAL 7016 Anthracite grey</td> <td>RAL 9001 Cream</td> </tr> <tr> <td>RAL 3003 Ruby red</td> <td>RAL 7035 Light grey</td> <td>RAL 9002 Grey white</td> </tr> <tr> <td>RAL 3004 Purple red</td> <td>RAL 7040 Window grey</td> <td>RAL 9006 White aluminium</td> </tr> <tr> <td>RAL 5010 Gentian blue</td> <td>RAL 8003 Clay brown</td> <td>RAL 9007 Grey aluminium</td> </tr> <tr> <td>RAL 5014 Pigeon blue</td> <td></td> <td></td> </tr> </table>														RAL 1015 Light ivory	RAL 6005 Moss green	RAL 8028 Terra brown	RAL 3000 Flame red	RAL 7016 Anthracite grey	RAL 9001 Cream	RAL 3003 Ruby red	RAL 7035 Light grey	RAL 9002 Grey white	RAL 3004 Purple red	RAL 7040 Window grey	RAL 9006 White aluminium	RAL 5010 Gentian blue	RAL 8003 Clay brown	RAL 9007 Grey aluminium	RAL 5014 Pigeon blue		
RAL 1015 Light ivory	RAL 6005 Moss green	RAL 8028 Terra brown																															
RAL 3000 Flame red	RAL 7016 Anthracite grey	RAL 9001 Cream																															
RAL 3003 Ruby red	RAL 7035 Light grey	RAL 9002 Grey white																															
RAL 3004 Purple red	RAL 7040 Window grey	RAL 9006 White aluminium																															
RAL 5010 Gentian blue	RAL 8003 Clay brown	RAL 9007 Grey aluminium																															
RAL 5014 Pigeon blue																																	
		Styles THP 410, THP 430 and THP 450 are not possible with a surface in Colour!																															
Decor																																	
Foil-coating, both sides																																	
Golden Oak		●	●	●					●	●	●	●	●	●	●																		
Dark Oak		●	●	●					●	●	●	●	●	●	●																		
Night Oak		●	●	●					●	●	●	●	●	●	●																		
Winchester Oak		●	●	●					●	●	●	●	●	●	●																		
Titan Metallic CH 703		●	●	●					●	●	●	●	●	●	●																		
Seals																																	
• Door leaf: 4-sided, double seals		●	●	●	●	●	●	●	●	●	●	●	●	●	●																		
• Frame: 3-sided seals		●	●	●																													
Lock																																	
• Multiple-point locking with main lock (with soft-lock latch) and 2 bolts, pivoting / hook bolt combination		●	●	●	●	●	●	●	●	●	●	●	●	●	●																		
• Main lock plate with adjustable latch slot																																	
• Secondary lock plates with eccentric adjustment																																	
Electric strikes																																	
Electric strike with day catch (separate)		○	○	○	○	○	○	○	○	○	○	○	○	○	○																		
Security bolts																																	
Security strip on the hinge side		●	●	●	●	●	●	●	●	●	●	●	●	●	●																		

● Standard
○ Optional

Thermo65 entrance doors

Entrance door programme

Product description



Product description	Thermo65 – steel THP													
	010	015	515	100	410	430	450	600	700	750	800	810	850	900
Version in RC 2														
Attack side = hinge side or opposite hinge side														
RC 2 with aluminium frame, hook bolt lock, profile cylinder with drilling and pull-off protection as well as security card and guide rollers	○	○	○											
RC 2 with aluminium frame, hook bolt lock, profile cylinder with drilling and pull-off protection as well as security card, guide rollers and safety glass P4A									○	○	○	○	○	○
RC 2 with side element / transom light (P4A safety glass)	○	○	○						○	○	○	○	○	○
Attack side = opposite hinge side														
RC 2 with aluminium frame, multiple-point locking (entrance door automation), profile cylinder with drilling and pull-off protection as well as security card and guide rollers	○	○	○											
RC 2 with aluminium frame, multiple-point locking (entrance door automation), profile cylinder with drilling and pull-off protection as well as security card, guide rollers and safety glass P4A									○	○	○	○	○	○
Size ranges														
Size ranges in which an RC 2 version is possible	○								○	○	○	○	○	○
832 – 1250 mm Width 1875 – 2250 mm Height														
875 – 1250 mm Width 1875 – 2250 mm Height		○	○											
Thermal insulation value (in W/(m²-K))														
► Dependent on the size and frame type	For a product description, see from page 26													
Fittings														
Hinges														
• 3 two-part guide rollers (180 mm)														
• 3-way adjustable	●	●	●	●	●	●	●	●	●	●	●	●	●	●
• With cover caps (stainless steel look)														
• With securing pins														
Door handle (exterior)														
• Exterior handle HB 14-2, brushed stainless steel	●	●	●	●	●	●	●	○	○	○	○	○	○	○
• Exterior handle HB 38-2, brushed stainless steel	○	○	○	○	○	○	○	●	●	●	●	●	●	●
Door handle (interior)														
• Stainless steel lever handle	●	●	●	●	●	●	●	●	●	●	●	●	●	●
Rose escutcheon (exterior and interior)														
• Oval stainless-steel profile cylinder rose escutcheons	●	●	●	●	●	●	●	●	●	●	●	●	●	●
Profile cylinder														
• Cylinder length 40.5 x 40.5 mm														
• With 5 keys	●	●	●	●	●	●	●	●	●	●	●	●	●	●
• With emergency and hazard function														
Glazing frame														
• Stainless steel, bonded									●	●	●	●	●	●
• Profile-style plastic, clipped				●	●	●								
Glazing														
• Triple-pane insulated glazing, exterior laminated safety glass – float sand-blasted with clear stripes – interior safety glass						●	●		●	●		●	●	●
• Triple-pane insulated glazing, exterior laminated safety glass – float sand-blasted – interior safety glass				●							●			
Frame														
• Aluminium block frame with thermal break (colour matching the door leaf)	●	●	●	●	●	●	●	●	●	●	●	●	●	●
• With aluminium / plastic threshold with thermal break (can be exchanged later)														
Side Element / Transom Light														
• For doors opening inwards	○	○	○	○	○	○	○	○	○	○	○	○	○	○
• For doors opening outwards	○	○	○	○	○	○	○	○	○	○	○	○	○	○

Thermo65 entrance doors

Entrance door programme

Technical presentation of door set



THP entrance doors with aluminium frame, profile A3

Standard sizes		
Overall frame dimension Ordering size	Clear frame dimensions	Structural opening
1000 x 2100	850 x 2005	1020 x 2110
1100 x 2100	950 x 2005	1120 x 2110

Special sizes		
THP Styles	Overall frame dimension	
	Width	Height
010/600/700/ 750/800/810	700-1250	1875-2250
850/900	800-1250	1875-2250
015/515	875-1250	1875-2250
100/410/430/450	875-1100	1875-2186

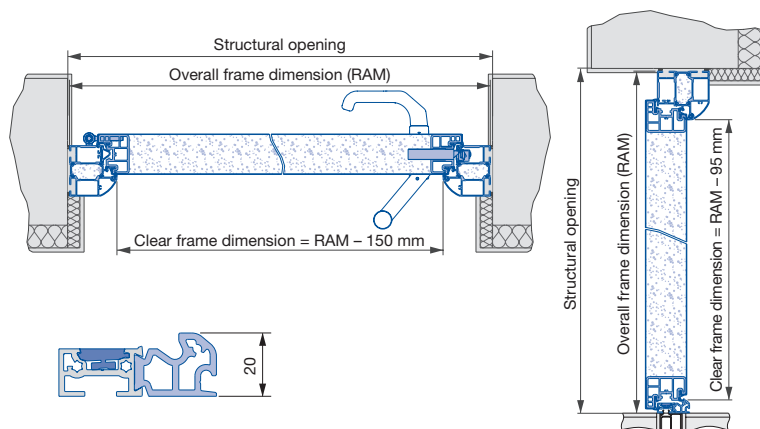

Wall connections for frames

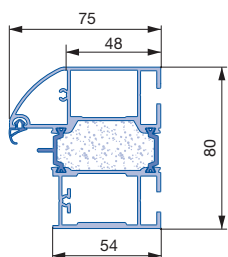

Profile A3

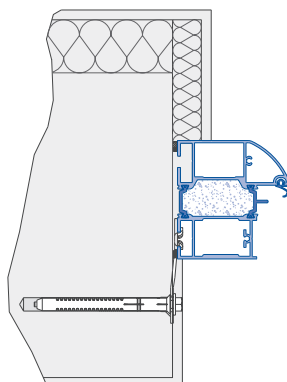

Aluminium frame
Anchor fitting

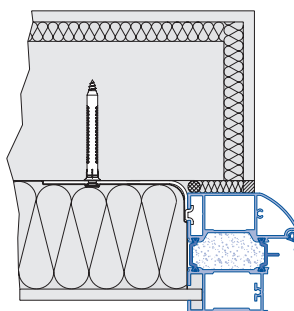

Aluminium frame
Anchor fitting

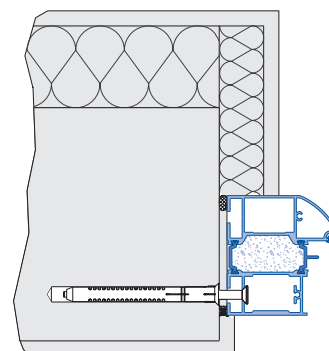

Aluminium frame
Countersunk fitting shown
(drill holes on site)

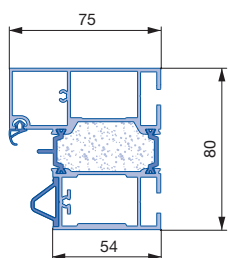

A4 profile

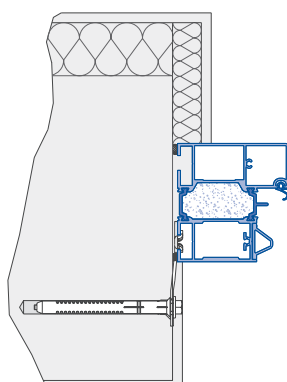

Aluminium frame
Anchor fitting

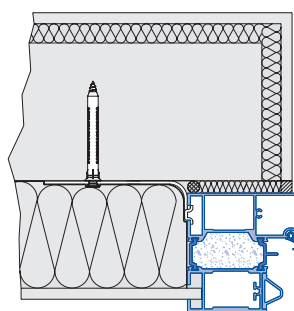

Aluminium frame
Anchor fitting

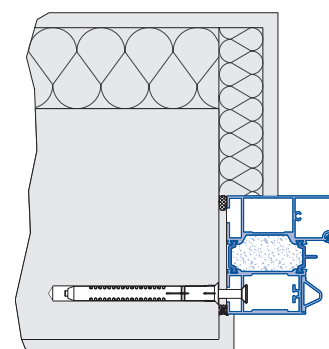

Aluminium frame
Countersunk fitting shown
(drill holes on site)

Thermo65 entrance doors

Entrance door programme

Technical presentation of door set



Wall connections for frames

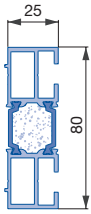

Extension profile 25 mm
(optional)

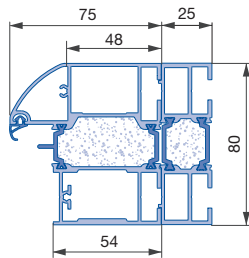

Aluminium frame A3 profile

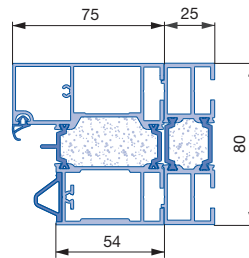

Aluminium frame A4 profile

Bottom edge

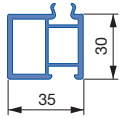

Bottom Spacer Profile
(optional)

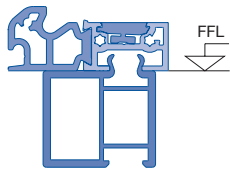

With 1 bottom spacer profile

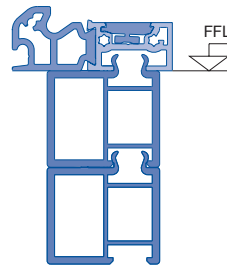

With 2 bottom spacer profiles

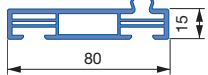

Base Frame Profile
(optional)

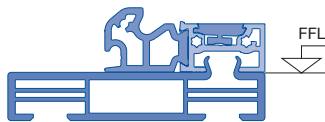

Base Frame Profile Under FFL

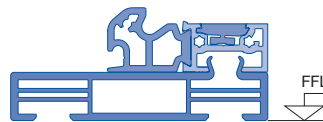

Base Frame Profile From FFL

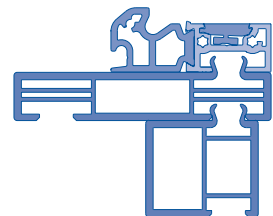

Base frame profile and bottom spacer profile can be combined

Thermo65 entrance doors

Entrance door programme

Technical presentation of door set with side element / transom light



THP entrance doors with side element/transom light

Standard sizes – Side element		
THP Styles	Overall frame dimension	
	Width	Height
All styles	400	2100

Special sizes – Side element		
THP Styles	Overall frame dimension	
	Width	Height
All styles	See pages 40 and 41	

Size range – Transom light		
THP Styles	Overall frame dimension	
	Width	Height
All styles	See page 40	

Clear view		
	Width	Height
Side element	RAM side element – 134	RAM side element – 134
Transom light	RAM transom light – 134	RAM transom light – 134

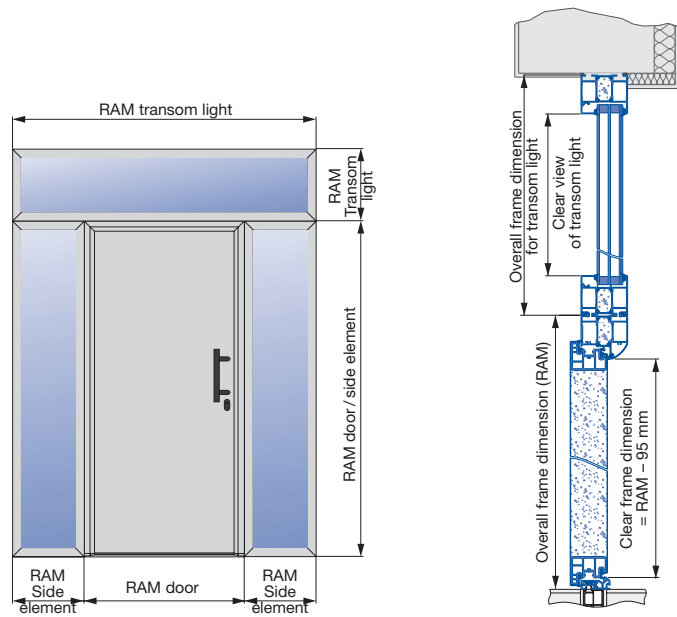
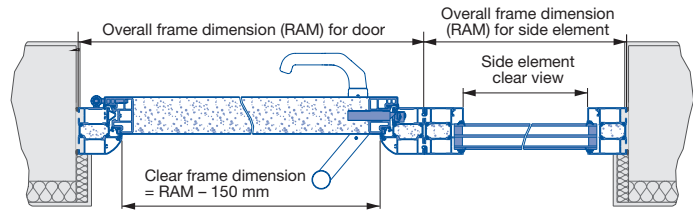
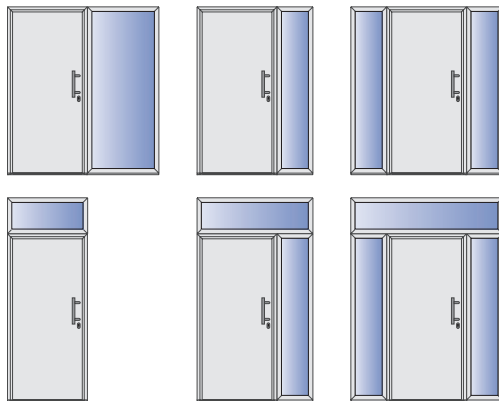

Thermo65 entrance doors

Entrance door programme

Technical presentation of clear view for doors with glazing



Clear view for styles with glazing

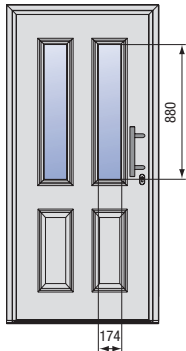

THP 410

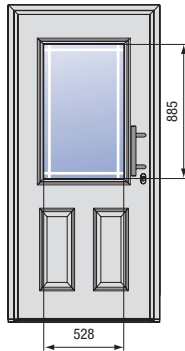

THP 430

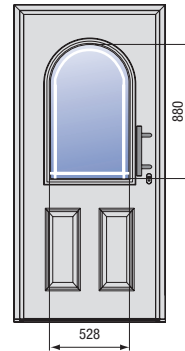

THP 450

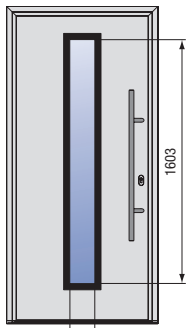

THP 600 // NEW

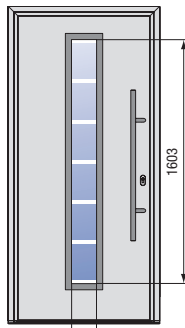

THP 700

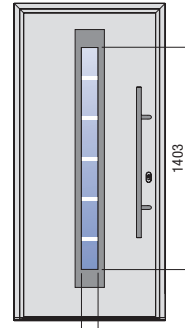

THP 750

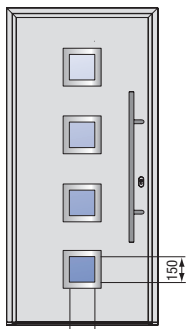

THP 800

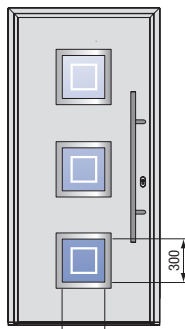

THP 810

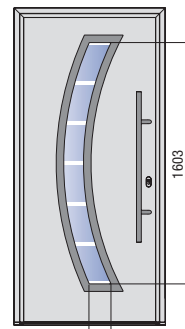

THP 850

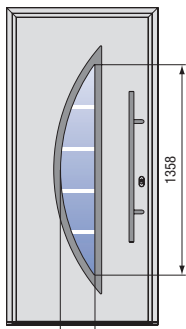

THP 900

Thermo65 Entrance Doors

Entrance door programme



For a product description, see from page 20

- Steel door leaf overlapping the frame, with thermal break, exterior and interior in same colour
- Aluminium frame
- Multiple-point lock

Colour 16 preferred colours (see page 20)
Decor Golden Oak, Dark Oak, Night Oak, Winchester Oak and Titan Metallic CH 703

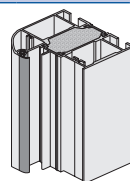

Profile A3

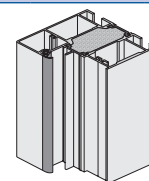

Profile A4

View	Style description	Size (RAM)	RAL 9016	Colour	Decor	RAL 9016	Colour	Decor
	Style THP 010 <ul style="list-style-type: none"> • Smooth sheet • Handle HB 14-2 	1000 × 2100	1399	1606	1645	1399	1606	1645
		1100 × 2100						
		From 700 × 1875 Up to 1250 × 2250	1728	1935	1974	1728	1935	1974
▶ U _D -value for size 1230 × 2180 mm: 0.87 W/(m ² ·K)								
	Style THP 015 <ul style="list-style-type: none"> • Ribbed sheet with 7 ribs • Handle HB 14-2 	1000 × 2100	1473	1680	1719	1473	1680	1719
		1100 × 2100						
		From 875 × 1875 Up to 1250 × 2250	1802	2009	2048	1802	2009	2048
▶ U _D -value for size 1230 × 2180 mm: 0.87 W/(m ² ·K)								
	Style THP 515 <ul style="list-style-type: none"> • Ribbed sheet with 3 ribs • Handle HB 14-2 	1000 × 2100	1473	1680	1719	1473	1680	1719
		1100 × 2100						
		From 875 × 1875 Up to 1250 × 2250	1802	2009	2048	1802	2009	2048
▶ U _D -value for size 1230 × 2180 mm: 0.87 W/(m ² ·K)								

Thermo65 entrance doors

Entrance door programme



For a product description, see from page 20

- Steel door leaf overlapping the frame, with thermal break, exterior and interior in same colour
- Aluminium frame
- Multiple-point lock

Colour 16 preferred colours (see page 20)



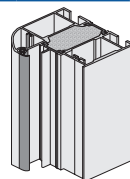

Decor Golden Oak, Dark Oak, Night Oak, Winchester Oak and Titan Metallic CH 703

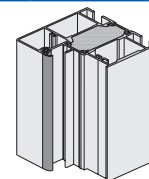

Profile A3



Profile A4

View	Style description	Size (RAM)	RAL 9016	Colour	Decor	RAL 9016	Colour	Decor
	Style THP 100 <ul style="list-style-type: none"> • Panelled sheet • Handle HB 14-2 	1000 × 2100	1426	1633	-	1426	1633	-
		1100 × 2100						
		From 875 × 1875 Up to 1100 × 2186	1755	1962	-	1755	1962	-
▶ U _D -value for size 1230 × 2180 mm: 0.87 W/(m ² ·K)								
	Style THP 410 <ul style="list-style-type: none"> • Panelled sheet • Plastic glazing frame • 3 panes of insulated glass, clear laminated safety glass, fully sand-blasted float and clear laminated safety glass • Handle HB 14-2 	1000 × 2100	2351	-	-	2531	-	-
		1100 × 2100						
		From 875 × 1875 Up to 1100 × 2186	2680	-	-	2680	-	-
▶ U _D -value for size 1230 × 2180 mm: 1.0 W/(m ² ·K)								
	Style THP 430 <ul style="list-style-type: none"> • Panelled sheet • Plastic glazing frame • 3 panes of insulated glass, clear laminated safety glass, sand-blasted float with clear stripes and clear laminated safety glass • Handle HB 14-2 	1000 × 2100	2351	-	-	2351	-	-
		1100 × 2100						
		From 875 × 1875 Up to 1100 × 2186	2680	-	-	2680	-	-
▶ U _D -value for size 1230 × 2180 mm: 1.0 W/(m ² ·K)								
	Style THP 450 <ul style="list-style-type: none"> • Panelled sheet • Plastic glazing frame • 3 panes of insulated glass, clear laminated safety glass, sand-blasted float with clear stripes and clear laminated safety glass • Handle HB 14-2 	1000 × 2100	2351	-	-	2351	-	-
		1100 × 2100						
		From 875 × 1875 Up to 1100 × 2186	2680	-	-	2680	-	-
▶ U _D -value for size 1230 × 2180 mm: 1.0 W/(m ² ·K)								

Thermo65 entrance doors

Entrance door programme



For a product description, see from page 20

- Steel door leaf overlapping the frame, with thermal break, exterior and interior in same colour
- Aluminium frame
- Multiple-point lock

Colour 16 preferred colours (see page 20)
Decor Golden Oak, Dark Oak, Night Oak, Winchester Oak and Titan Metallic CH 703

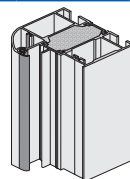

Profile A3

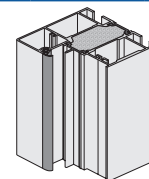

Profile A4

View	Style description	Size (RAM)	RAL 9016	Colour	Decor	RAL 9016	Colour	Decor
	Style THP 600 // NEW <ul style="list-style-type: none"> • Smooth sheet • 3 panes of insulated glass, exterior and interior safety glass pane, sand-blasted float middle pane, surface-mounted exterior pane • Handle HB 38-2 	1000 × 2100	2468	2675	2714	2468	2675	2714
		1100 × 2100						
		From 700 × 1875 Up to 1250 × 2250	2797	3004	3044	2797	3004	3044

Available from 1.7.2017

	Style THP 700 <ul style="list-style-type: none"> • Smooth sheet • 3 panes of insulated glass, clear single-pane safety glass, sand-blasted float with clear horizontal stripes and clear laminated safety glass • Stainless steel glazing frame • Handle HB 38-2 	1000 × 2100	2194	2401	2440	2194	2401	2440
		1100 × 2100						
		From 700 × 1875 Up to 1250 × 2250	2523	2730	2769	2523	27230	2769

► U_D-value for size 1230 × 2180 mm: 0.98 W/(m²·K)

	Style THP 750 <ul style="list-style-type: none"> • Smooth sheet • 3 panes of insulated glass, clear single-pane safety glass, sand-blasted float with clear horizontal stripes and clear laminated safety glass • Stainless steel glazing frame • Handle HB 38-2 	1000 × 2100	2194	2401	2440	2194	2401	2440
		1100 × 2100						
		From 700 × 1875 Up to 1250 × 2250	2523	2730	2769	2523	2730	2769

► U_D-value for size 1230 × 2180 mm: 0.95 W/(m²·K)

	Style THP 800 <ul style="list-style-type: none"> • Smooth sheet • 3 panes of insulated glass, clear laminated safety glass, sand-blasted float and clear laminated safety glass • Stainless steel glazing frame • Handle HB 38-2 	1000 × 2100	2356	2563	2602	2356	2563	2602
		1100 × 2100						
		From 700 × 1875 Up to 1250 × 2250	2685	2892	2931	2685	2892	2931

► U_D-value for size 1230 × 2180 mm: 0.93 W/(m²·K)

Thermo65 entrance doors

Entrance door programme



For a product description, see from page 20

- Steel door leaf overlapping the frame, with thermal break, exterior and interior in same colour
- Aluminium frame
- Multiple-point lock

Colour 16 preferred colours (see page 20)

Decor Golden Oak, Dark Oak, Night Oak, Winchester Oak and Titan Metallic CH 703

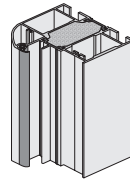

Profile A3

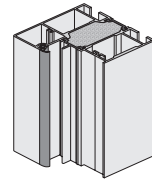

Profile A4

View	Style description	Size (RAM)	RAL 9016	Colour	Decor	RAL 9016	Colour	Decor
	Style THP 810 <ul style="list-style-type: none"> • Smooth sheet • 3 panes of insulated glass, clear single-pane safety glass, sand-blasted float with clear squares and clear laminated safety glass • Stainless steel glazing frame • Handle HB 38-2 	1000 × 2100	2356	2563	2602	2356	2563	2602
		1100 × 2100						
		From 700 × 1875 Up to 1250 × 2250	2685	2892	2931	2685	2892	2931
▶ U _D -value for size 1230 × 2180 mm: 0.99 W/(m ² ·K)								
	Style THP 850 <ul style="list-style-type: none"> • Smooth sheet • 3 panes of insulated glass, clear laminated safety glass, sand-blasted float with clear horizontal stripes and clear laminated safety glass • Stainless steel glazing frame • Handle HB 38-2 	1000 × 2100	2547	2754	2793	2547	2754	2793
		1100 × 2100						
		From 800 × 1875 Up to 1250 × 2250	2876	3083	3122	2876	3083	3122
▶ U _D -value for size 1230 × 2180 mm: 0.96 W/(m ² ·K)								
	Style THP 900 <ul style="list-style-type: none"> • Smooth sheet • 3 panes of insulated glass, clear single-pane safety glass, sand-blasted float with clear horizontal stripes and clear laminated safety glass • Stainless steel glazing frame • Handle HB 38-2 	1000 × 2100	2356	2563	2602	2356	2563	2602
		1100 × 2100						
		From 800 × 1875 Up to 1250 × 2250	2685	2892	2931	2685	2892	2931
▶ U _D -value for size 1230 × 2180 mm: 0.96 W/(m ² ·K)								

Thermo65 entrance doors

Entrance door programme

Accessories



Exterior door handles (included in door price) £

	<p>Handle HB 14-2</p> <ul style="list-style-type: none"> • Brushed stainless steel • As standard for styles THP 010, THP 015, THP 100, THP 410, THP 430, THP 450 and THP 515 	<p>Surcharge for conversion to handle HB 14-2</p>	<p>118</p>
--	---	---	-------------------

	<p>Handle HB 38-2</p> <ul style="list-style-type: none"> • Brushed stainless steel • As standard for styles THP 700, THP 750, THP 800, THP 810, THP 850 and THP 900 	<p>Surcharge for conversion to handle HB 38-2</p>	<p>118</p>
--	--	---	-------------------

	<p>// NEW Handle HB 38-3</p> <ul style="list-style-type: none"> • Brushed stainless steel 	<p>Surcharge for conversion to handle HB 38-3</p>	<p>118</p>
--	--	---	-------------------

ES 0 fittings Including profile cylinder with 5 keys Surcharges £

	<p>Knob / lever</p>	<p>Stainless steel</p>	<p>Each</p>	<p>118</p>
--	---------------------	------------------------	-------------	-------------------

	<p>Lever / lever</p>	<p>Stainless steel</p>	<p>Each</p>	<p>118</p>
--	----------------------	------------------------	-------------	-------------------

ES 1 fittings Including profile cylinder with 5 keys Surcharges £

	<p>Knob / lever</p>	<p>Stainless steel</p>	<p>Each</p>	<p>320</p>
--	---------------------	------------------------	-------------	-------------------

	<p>Lever / lever</p>	<p>Stainless steel</p>	<p>Each</p>	<p>320</p>
--	----------------------	------------------------	-------------	-------------------

Thermo65 Entrance Doors

Entrance door programme

Accessories



Rose escutcheons	Including profile cylinder with 5 keys		Surcharges	£
	// NEW Knob / lever handle, type D-110	Stainless steel	Each	118
	Lever handle / lever handle, type D-110	Stainless steel	Each	118
	// NEW Lever handle / lever handle, type D-210	Stainless steel	Each	118
	// NEW Lever handle / lever handle, type D-310	Stainless steel	Each	118
	// NEW Lever handle / lever handle, type D-510	Stainless steel	Each	118

Calculation example		£
Conversion THP 010 with HB 14-2 to HB 38-2		Style THP 010 in RAL 9016, profile A3 (standard size) 1399
		+ Conversion from handle HB 14-2 to handle HB 38-2 118
		= Total 1517
Conversion THP 700 with HB 38-2 to Fitting ES 1		Style THP 700 in RAL 9016, profile A3 (standard size) 2194
		+ Surcharge for ES 1 stainless steel knob / lever handle fitting 320
		= Total 2514

Thermo65 Entrance Doors

Entrance door programme

Accessories



Profile cylinders £

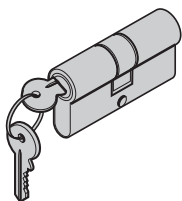

Profile cylinder (40.5 + 40.5 mm) For HB 14-2 and HB 38-2 push bars	With 8 keys	Each	48
	With 10 keys	Each	56
Profile cylinder (45.5 + 45.5 mm) For ES 0 fittings	With 5 keys	Each	34
	With 8 keys	Each	48
	With 10 keys	Each	56
Profile cylinder (45.5 + 40.5 mm) with drilling and pull-off protection and security card for HB 14-2 and HB 38-2 push bars with security rose escutcheon ES 1	With 5 keys	Each	73
	With 8 keys	Each	99
	With 10 keys	Each	117
Profile cylinder (45.5 + 45.5 mm) with drilling and pull-off protection and security card For ES 1 fittings	With 5 keys	Each	73
	With 8 keys	Each	99
	With 10 keys	Each	117
Profile cylinder, keys to pass, for push bar or ES 0 fittings	With 5 keys	Each	34
	With 8 keys	Each	48
	With 10 keys	Each	56
Profile cylinder, keys to pass, with drilling and pull-off protection and security card for ES 1 fittings	With 5 keys	Each	73
	With 8 keys	Each	99
	With 10 keys	Each	117

Note:

No keys to pass for the profile cylinder from the fitting package

Note:

No keys to pass for the profile cylinder from the fitting package

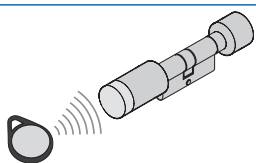

Electromechanical profile cylinder

- Including 5 transponders
- For Thermo65 with handle HB 14-2 / HB 38-2 and oval rose escutcheon

Per door **486**



Additional transponder

- For electromechanical profile cylinder

Each **18**

Multiple-point locking £

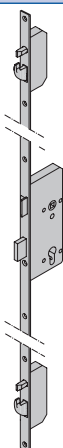

// NEW
Available from 1.7.2017

Automatic lock

- Multiple-point locking with main lock and 2 bolts, pivoting / hook bolt combination
- Mechanical self-locking mechanism

Per door **118**

Thermo65 Entrance Doors

Entrance door programme

Accessories



Entrance door automation

£

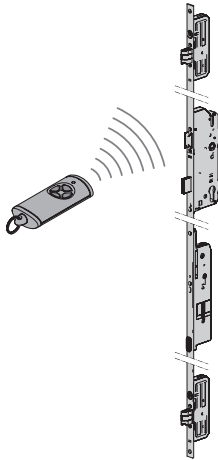

Multiple-point locking with opening via a hand transmitter

- Automatic lock with electric motor
- Including 1 hand transmitter HSE 4 BS
- For Thermo65 with handle HB 14-2/ HB 38-2
- For Thermo65 with lever / knob handle set ES 0/ ES 1

Per door **865**

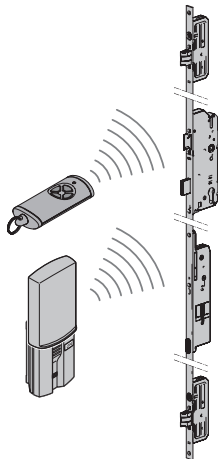

Multiple-point locking with opening via a radio finger-scan and hand transmitter

- Automatic lock with electric motor
- Including 1 hand transmitter HSE 4 BS and 1 finger-scan FFL 12 BS
- For Thermo65 with handle HB 14-2/ HB 38-2
- For Thermo65 with lever / knob handle set ES 0/ ES 1

Per door **1045**

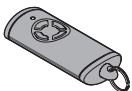

Additional 4-button hand transmitter HSE 4 BS

- In black
- Textured plastic surface with plastic caps

Each **62**

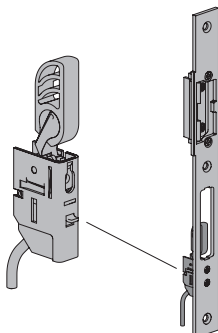

Latch switching contact

For main latch, central lock

Each **94**

Thermo65 Entrance Doors

Entrance door programme

Accessories



Door leaf and frame in different colours / surfaces

Colours of door leaf and frame differ

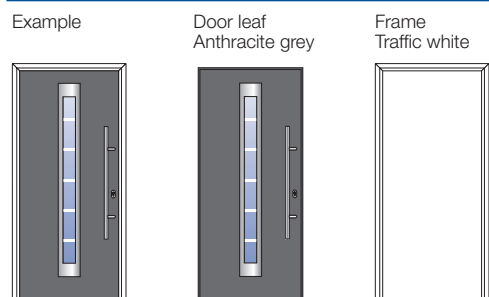

Door leaf	Frame	Price for entrance door with surface
RAL 9016	Colour	Colour
RAL 9016	Decor	Decor
Colour	RAL 9016	Colour
Colour	Decor	Decor
Decor	RAL 9016	Decor
Decor	Colour	Decor

Bi-colour entrance doors and side elements

- Door leaf and frame / side element / transom light
 - Exterior in decors Golden Oak, Dark Oak or Titan Metallic CH 703
 - Interior in Traffic white RAL 9016
- For frame profile A3
- Opening inwards
- Not possible for styles THP 100, THP 410, THP 430 and THP 450!

	Surcharge	£
	Per door	109
Surcharge for version with decor surface	Per side element	52
	Per transom light	52

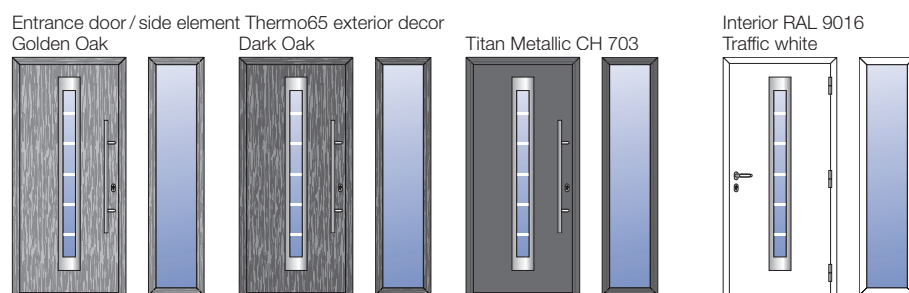

Example THP 750

Thermo65 Entrance Doors

Entrance door programme

Accessories

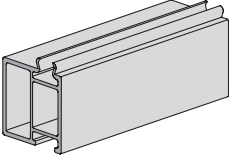
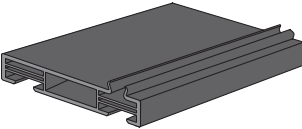
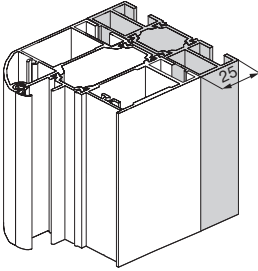
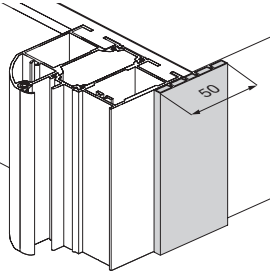
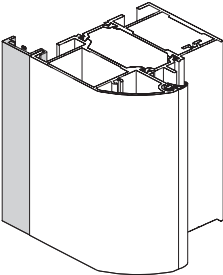
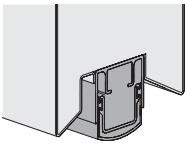

Profiles					£	
	Bottom Spacer Profile	Length up to 1250 mm	Height 30 mm	Each	24	
			Height 60 mm	Each	47	
			Height 90 mm	Each	70	
			Height 120 mm	Each	93	
			Height 150 mm	Each	116	
		Length up to 2250 mm	Height 30 mm	Each	39	
			Height 60 mm	Each	77	
			Height 90 mm	Each	116	
			Height 120 mm	Each	154	
			Height 150 mm	Each	192	
		Length up to 3250 mm	Height 30 mm	Each	55	
			Height 60 mm	Each	110	
Height 90 mm	Each		165			
Height 120 mm	Each		220			
Height 150 mm	Each		275			
	Base Frame Profile (black)	Length up to 1250 mm	Height 15 mm	Each	24	
		Length up to 2250 mm	Height 15 mm	Each	39	
		Length up to 3250 mm	Height 15 mm	Each	55	
	Extension profile 25 mm Dimensions (W x D): 25 x 80 mm	RAL 9016	Per m	54		
		Colour	Per m	63		
		Golden Oak, Dark Oak, Night Oak, Winchester Oak, Titan Metallic CH 703	Per m	66		
	Cover Profile Per package 2 x 2300 mm and 1 x 1300 mm Dimensions (W x D): 50 x 5 mm Profiles sufficient for a door without side elements	RAL 9016	Per box	110		
		Golden Oak, Dark Oak, Night Oak, Winchester Oak, Titan Metallic CH 703	Per box	147		
	Supplementary profile (on three sides) Width 20 mm, mitred, incl. corner bracket and fitting screws	RAL 9016	Per door	226		
		Colour	Per door	285		
		Golden Oak, Dark Oak, Titan Metallic CH 703	Per door	294		
Retractable bottom seal						
	Retractable bottom seal (Frame without threshold)				Each	259
		Notes: <ul style="list-style-type: none"> • Not for style 100, 410, 430 and 450! • Not possible in conjunction with RC 2! • The thermal insulation (UD) and water-tightness performance characteristics are limited under heavy rain! 				

Thermo65 Entrance Doors

Entrance door programme

Accessories



Accessories		£
	Spyhole (only for THP 010, THP 015, THP 100, THP 410 and THP 515)	Each 47
 (10x)	Fitting set 10 x screws and 10 x plugs	Per set 21
	Screw-in anchor set Length 280 mm (8 x anchors)	Per set 27
	Rain canopy Anodised aluminium	Each 21
	Door drip	RAL 9016 Traffic white Each 32 Stainless steel look Each 48
		
	Electric strike with day catch (separate)	Each 75
	Door set opening outwards	Per door 70
	Stainless steel cleaner and care product (150 ml)	Each 30
	Pre-compressed sealing strip (74 mm wide) for groove widths from 6 – 15 mm 5.90 m roll (approved for RAL fitting)	Per roll 105
Door closer		£
	Door leaf prepared for overhead door closer (reinforcement in door leaf)	Each 28
	Overhead door closer HDC 35 for fitting on the hinge side For Thermo65 entrance doors with aluminium frame, profile A3 or A4	Each 161
	Overhead door closer HDC 35 for fitting on the opposite hinge side For Thermo65 entrance doors with aluminium frame, profile A4	Each 161
	Mechanical hold-open device	Each 61

Thermo65 Entrance Doors

Entrance door programme

Accessories



Entrance door in RC 2 version (for a product description, see page 20) £

- ▶ Hook bolt lock: attack side = opposite hinge side or hinge side
- ▶ Multiple-point locking (building automation): attack side = opposite hinge side

	Package HB 14-2 with security rose escutcheon		Stainless steel	Per door	252
	ES 1 fittings	Knob / lever	Stainless steel	Per door	320
		Lever / lever	Stainless steel	Per door	320

	Package HB 38-2 with security rose escutcheon and safety glass A3 (P4A)		Stainless steel	Per door	379
	ES 1 fittings and safety glass A3 (P4A)	Knob / lever	Stainless steel	Per door	447
		Lever / lever	Stainless steel	Per door	447

Approved size range for RC 2 version for each style

Width	832 x 1250	875 x 1250
Height	1875 x 2250	1875 x 2250

Side elements and transom lights in RC 2 £

<p>Side element</p>	<p>Only possible in the size range with a width of 400 – 550 mm (overall frame dimension).</p>	Clear glass and safety glass A3 (P4A)	Per side element	157
		Sand-blasted float and safety glass A3 (P4A)	Per side element	157
		Sand-blasted float with clear stripes and safety glass A3 (P4A)	Per side element	157
<p>Transom light</p>	<p>Only possible in the size range with a height of 400 – 500 mm (overall frame dimension).</p>	Clear glass and safety glass A3 (P4A)	Per transom light	157
		Sand-blasted float and safety glass A3 (P4A)	Per transom light	157

Example for calculating an entrance door in an RC 2 version £





<p>Conversion THP 700 with HB 38-2 to Package HB 38-2 with security rose escutcheon</p>		<p>Style THP 700 in RAL 9016, profile A3 (standard size) 2194</p> <p>+ Conversion for package HB 38-2 with security rose escutcheon 379</p> <p>= Total 2573</p>
--	--	--

Thermo65 Entrance Doors

Entrance door programme

Accessories

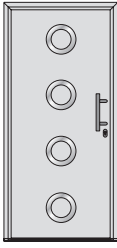

Embellishments in stainless steel look for style THP 010 (on the exterior)				Surcharge	£
	View 451	// NEW Stainless steel frame Overall dimension 240 x 240 mm Inside dimension 160 x 160 mm	Style THP 010	Per door	223
	View 454	// NEW Stainless steel frame Overall dimension 145 x 145 mm	Style THP 010	Per door	223
	View 457	// NEW Curved stainless steel frame	Style THP 010	Per door	223
	View 459	// NEW Stainless steel rings Overall dimension Ø 240 mm Inside dimension Ø 160 mm	Style THP 010	Per door	223
	View 460	// NEW Stainless steel frame over entire leaf height	Style THP 010	Per door	223
	View 461	// NEW 3 parallel stainless steel strips over the entire leaf height	Style THP 010	Per door	223

Thermo65 Entrance Doors

Entrance door programme

Accessories



Embellishments in stainless steel look (on the exterior)

£



THP 015



THP 515

Embellishment in stainless steel look view 400
Inlay length 577 mm per rib

Style THP 015 Per door **174**

Style THP 515 Per door **116**



THP 015

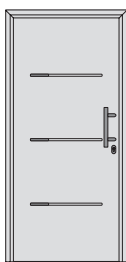

THP 515

Embellishment in stainless steel look view 401
Inlay length 118 mm per rib

Style THP 015 Per door **174**

Style THP 515 Per door **116**



THP 015



THP 515

Embellishment in stainless steel look view 402
Inlay length 118 mm per rib

Style THP 015 Per door **174**

Style THP 515 Per door **116**



THP 015



THP 515

Embellishment in stainless steel look view 403
Inlay length 2 x 118 mm per rib

Style THP 015 Per door **174**

Style THP 515 Per door **116**

Stainless steel bottom sheet (on the exterior)

£



Stainless steel bottom sheet
(separate)

- Bottom sheet height 110 mm
- Size range of heights for style

Style	Height (RAM)
010	1875–2250 mm
100 / 410 / 430 / 450 / 015 / 515 / 700 / 750 / 800 / 810 / 850 / 900	2050–2250 mm

Per door **164**

Thermo65 Entrance Doors

Entrance door programme

Side elements and transom lights



Side element

Fixed side element assembly

Standard size

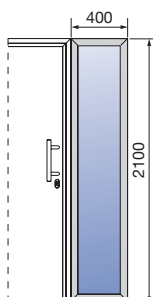

Ordering sizes RAM (mm) Width x height	Glass	RAL 9016	Colour	Decor
400 x 2100	Clear glass	883	995	1033
	Sand-blasted float	883	995	1033
	Sand-blasted float with clear stripes	1362	1473	1511

Side element

Fixed side element assembly

Special sizes

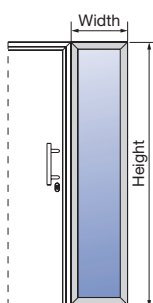

Ordering sizes RAM up to (mm) Width x Height	Glass	RAL 9016	Colour	Decor
From 300 x 1875 to 500 x 2250 to 1000 x 2250 *	Clear glass or sand-blasted float according to overview on page 39	1053	1166	1203
		1220	1333	1369
From 300 x 1875 to 500 x 2250 to 1000 x 2250 *	Sand-blasted float with clear stripes according to overview on page 39	1657	1770	1806
		1823	1935	1974

* Only possible without transom light
Door set with side element does not have a statics function.
Statics must be ensured by the building structure.

Transom light

Fixed transom light assembly

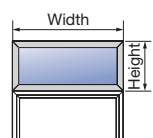

Ordering sizes RAM (mm) Width x Height	Glass	RAL 9016	Colour	Decor
From 875 x 300 to 1250 x 500 to 1750 x 500 Up to 2250 x 500	Clear glass or sand-blasted float according to overview on page 39	709	823	860
		855	968	1005
		1053	1166	1203

Thermo65 entrance doors

Entrance door programme

Overview of glass for side elements

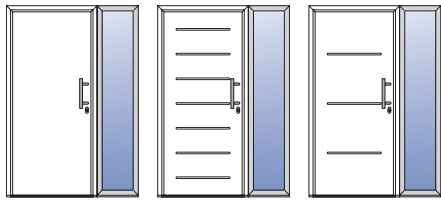
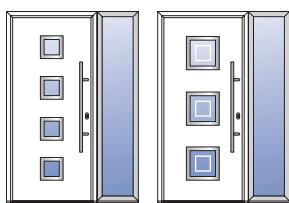
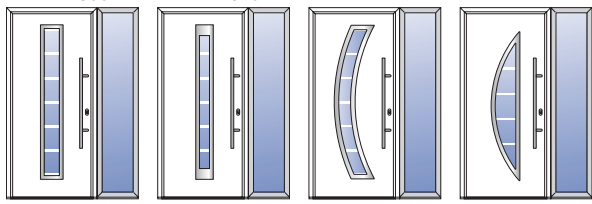
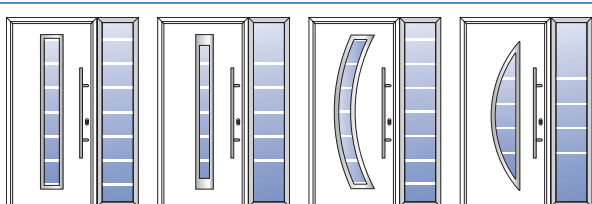
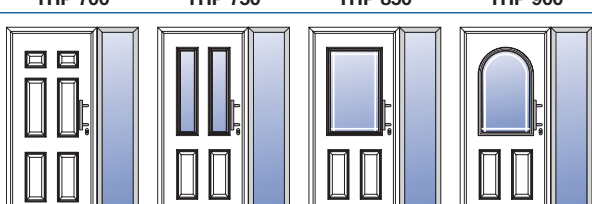

Infill / size range

Style	Glass	Size Range	
		Side element	Transom light
 <p>THP 010 THP 015 THP 515</p>	<ol style="list-style-type: none"> 1. Clear laminated safety glass / sand-blasted float without clear stripes / clear laminated safety glass 2. Clear laminated safety glass / float / clear laminated safety glass 	<p>Width 300 – 1000 mm</p> <p>Height 1875 – 2250 mm</p>	<p>Width 700 – 2250 mm</p> <p>Height 300 – 500 mm</p>
 <p>THP 800 THP 810</p>			
 <p>THP 700 THP 750 THP 850 THP 900</p>	<ol style="list-style-type: none"> 1. Clear laminated safety glass / sand-blasted float with clear stripes / clear laminated safety glass (only in side element) 	<p>Width 300 – 1000 mm</p> <p>Height 1875 – 2250 mm</p>	<p>Width 700 – 2250 mm</p> <p>Height 300 – 500 mm</p>
 <p>THP 700 THP 750 THP 850 THP 900</p>			
 <p>THP 100 THP 410 THP 430 THP 450</p>	<ol style="list-style-type: none"> 1. Clear laminated safety glass / sand-blasted float without clear stripes / clear laminated safety glass 2. Clear laminated safety glass / float / clear laminated safety glass 	<p>Width 300 – 1000 mm</p> <p>Height 1875 – 2186 mm</p>	<p>Width 875 – 2000 mm</p> <p>Height 300 – 500 mm</p>

Steel Security Doors RC 2

KSI Thermo46 with thick rebate, sheet thickness 0.6 – 0.8 mm

Standard/special sizes

RC 2

46



With thermal breaks!

Product description		Standard sizes	State handling	
Break-in-resistant, ready-to-fit door set, single-leaf, tested according to DIN EN 1627 resistance class RC 2, for fitting to brickwork, concrete.			With aluminium block frame (profile A2)	
Attack side = opposite hinge side				
Door leaf			Ordering sizes (overall frame dimension)	
46 mm thick, "Modern" smooth sheet steel, thick rebate, fully foamed, with thermal break, exterior and interior overlapping the leaf and matching colour.			875 × 2000	1297
4-sided, double EPDM seals, black, with continuous lip seal in the bottom sheet, additional EPDM form parts in both bottom corners for additional sealing, incl. brush seal in the frame			875 × 2125	1297
			1000 × 2000	1329
		1000 × 2100	1329	
		1000 × 2125	1329	
		1100 × 2100	1329	
Frame		Special sizes	State handling	
<ul style="list-style-type: none"> Aluminium block frame profile A2 with aluminium/ plastic threshold With thermal break Colour matching the door leaf 			With aluminium block frame (profile A2)	
Surface			Ordering sizes (overall frame dimension)	
<ul style="list-style-type: none"> Standard: Painted in Traffic white on both sides, based on RAL 9016, silk matt, gloss level 35 – 40 % Colour: 16 preferred colours, painted on both sides, based on the RAL colour chart, silk matt, gloss level 35 – 40 % 		From 832 × 1875 Up to 1250 × 2250	1658	
Fittings		Preferred colour (Colour)		
<ul style="list-style-type: none"> Multiple-point locking with main lock (with soft-lock latch) and 2 bolts, pivoting / hook bolt combination Stainless steel long escutcheon lever / knob handle set ES 1 3 × anti-leverage guard 5 keys Security certificate 		Door leaf and frame in preferred colour (Colour) 207		
Hinges		<ul style="list-style-type: none"> RAL 1015 Light ivory RAL 3000 Flame red RAL 3003 Ruby red RAL 3004 Purple red RAL 5010 Gentian blue RAL 5014 Pigeon blue RAL 6005 Moss green RAL 7016 Anthracite grey RAL 7035 Light grey RAL 7040 Window grey RAL 8003 Clay brown RAL 8028 Terra brown RAL 9001 Cream RAL 9002 Grey white RAL 9006 White aluminium RAL 9007 Grey aluminium 		
<ul style="list-style-type: none"> 3 two-part guide rollers (180 mm), 3-way adjustable 		Decor 246		
		Door leaf and frame in decor		
		<ul style="list-style-type: none"> Golden Oak Dark Oak Night Oak Winchester Oak Titan Metallic CH 703 		
Accessories				
Spyhole, fitted		Each	47	
Slide rail overhead door closer HDC 35		Each	161	
Prepared for overhead door closer (reinforcement in door leaf)		Each	28	
Lever handle / lever handle, ES 1 stainless steel		No surcharge		
Electric strike with day catch (separate)			75	
		Height 30 mm	Each 24	
		Height 60 mm	Each 47	
Bottom Spacer Profile		Height 90 mm	Each 70	
		Height 120 mm	Each 93	
		Height 150 mm	Each 116	
Pre-compressed sealing strip (56 mm wide) for groove widths from 6 – 15 mm, 5.90 m roll		Per roll	81	
Door drip		RAL 9016	Each 32	
		Stainless steel look	Each 48	
Stainless steel bottom sheet (separate), height 110 mm		Each	164	
Fitting set (10 × screws and 10 × plugs)		Per set	21	
Retractable bottom seal (frame without threshold)				
<ul style="list-style-type: none"> The thermal insulation (U_D) and watertightness performance characteristics are limited under heavy rain! 		Each	259	

MZ Thermo46 Thick Rebate – Steel

Sheet thickness 0.6–0.8 mm

Standard / special sizes

Product description

- Steel door leaf overlapping the frame, with thermal break, exterior and interior in same colour
- Aluminium frame for fitting to brickwork and concrete
- Mortice lock (single locking) prepared for profile cylinder and 3 keys, without emergency and hazard function
- ▶ Ordering size = overall frame dimension (nominal size)

Colour

RAL 1015	Light ivory	RAL 6005	Moss green	RAL 9001	Cream
RAL 3000	Flame red	RAL 7016	Anthracite grey	RAL 9002	Grey white
RAL 3003	Ruby red	RAL 7035	Light grey	RAL 9006	White aluminium
RAL 3004	Purple red	RAL 7040	Window grey	RAL 9007	Grey aluminium
RAL 5010	Gentian blue	RAL 8003	Clay brown		
RAL 5014	Pigeon blue	RAL 8028	Terra brown		

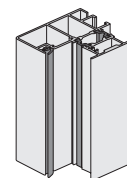

A2 profile

Decor

Golden Oak, Dark Oak, Night Oak, Winchester Oak and Titan Metallic CH 703

View	Style description	Size (RAM)	RAL 9016	Colour	Decor
	Style TPS 011 • 3 two-part guide rollers (180 mm), three-way adjustable with cover caps (aluminium / stainless steel lock) • Lever handle set (lever / lever) made of plastic, black, rose escutcheon ▶ Handing as specified!	875 × 2000	766	972	1012
		875 × 2125			
		1000 × 2000	798	1004	1043
		• 1000 × 2100			
• 1000 × 2125					
• 1100 × 2100					
From 700 × 1750	1127	1333	1372		
Up to 1250 × 2250					
▶ U _D -value for size 1230 × 2180 mm: 1.1 W/(m ² ·K)					
	Style TPS 021 • 3 two-part guide rollers (180 mm), three-way adjustable with cover caps (aluminium / stainless steel lock) • Double-pane insulated glazing, 28 mm thick, exterior single-pane safety glass, interior sand-blasted laminated safety glass • Plastic glazing frame in door frame colour ¹⁾ • Lever handle set (lever / lever) made of plastic, black, rose escutcheon ▶ Handing as specified!	875 × 2000	1141	1592	1632
		875 × 2125			
		1000 × 2000	1171	1621	1662
		1000 × 2100			
1000 × 2125					
1100 × 2100					
From 700 × 1875	1500	1950	1991		
Up to 1250 × 2250					
▶ U _D -value for size 1230 × 2180 mm: 1.4 W/(m ² ·K)					
	Style TPS 051 • 3 two-part guide rollers (180 mm), three-way adjustable with cover caps (aluminium / stainless steel lock) • Double-pane insulated glazing, 28 mm thick, exterior single-pane safety glass, interior sand-blasted laminated safety glass • Plastic glazing frame in door frame colour ¹⁾ • Lever handle set (lever / lever) made of plastic, black, rose escutcheon ▶ Handing as specified!	875 × 2000	1141	1592	1632
		875 × 2125			
		1000 × 2000	1171	1621	1662
		1000 × 2100			
1000 × 2125					
1100 × 2100					
From 875 × 1875	1500	1950	1991		
Up to 1250 × 2250					
▶ U _D -value for size 1230 × 2180 mm: 1.6 W/(m ² ·K)					
	Style TPS 081 • 2 two-part guide rollers (180 mm), three-way adjustable with cover caps (aluminium / stainless steel lock) • Lever handle set (lever / lever) made of plastic, black, short escutcheon ▶ No further accessories / decors / colours are possible in dual handed doors!	875 × 2000	766	-	-
		875 × 2125			
		1000 × 2000	798	-	-
		1000 × 2100			
1000 × 2125					
1100 × 2100					
▶ Dual handed! U _D -value for size 1230 × 2180 mm: 1.1 W/(m ² ·K)					

Sizes marked with a dot (•) indicate doors in RAL 9016 that are **available from stock**.

1) For decor door surface finishes, the plastic glazing frames are coated in a colour matching the decor

With thermal breaks



Accessories

Door closers			
Prepared for overhead door closer (reinforcement in door leaf)			28
Slide rail overhead door closer HDC 35			161
Mechanical hold-open device		Each	61
Fittings			
			£
Lever handle set type D-110, rose escutcheon, prepared for profile cylinder	Black plastic (standard)		81
	Anodised aluminium (F1) *		177
	Brushed stainless steel *		232
Lever / knob handle set type D-110, rose escutcheon, prepared for profile cylinder	Black plastic *		123
	Anodised aluminium (F1) *		190
	Brushed stainless steel *		245
Multiple-point locking (hook bolt lock) with rose escutcheon (stainless steel lever handle / lever handle)	See dealer price list 01-17 part A, chapter Entrance Doors Thermo46		
Anti-panic fittings acc. to DIN EN 179 (opening outwards)			
			£
Single-point locking (panic lock with stainless steel cover, distance 92 mm, left-hand hinged or right-hand hinged)	With anti-panic function E		147
	With split spindle, passage function D		178
Multiple-point locking (panic lock with stainless steel cover, distance 92 mm, left-hand hinged or right-hand hinged) ▶ Possible from door height 1990 mm	With anti-panic function E		440
	With split spindle, passage function D		496
Lever / knob handle set type D-110, rose escutcheon, prepared for profile cylinder	Black plastic *		123
	Anodised aluminium (F1) *		190
	Brushed stainless steel *		245
Anti-panic lever handle set type D-110 with split spindle, rose escutcheon, prepared for profile cylinder	Black plastic *		123
	Anodised aluminium (F1) *		190
	Brushed stainless steel *		245
Profiles			
			Per m £
Extension profile 25 mm	RAL 9016		49
	Colour		58
	Decor		61
Extension profile 50 mm	RAL 9016		54
	Colour		63
	Decor		66
Cover Profile (package is sufficient for one door set)	RAL 9016	Per box	110
	Decor	Per box	147
	RAL 9016	Per door	226
Supplementary profile (3-sided), width 20 mm, mitred, incl. corner bracket and fitting screws	Colour	Per door	285
	Golden Oak, Dark Oak, Titan Metallic CH 703	Per door	294
Accessories			
Retractable bottom seal (frame without threshold)			259
Spyhole (TPS 011)			47
Electric strike with day catch (separate)			75
Stainless steel bottom sheet (separate), height 110 mm	Styles 011 / 051	Height RAM 1875 – 2250 mm	Each
	Style 021	Height RAM 2050 – 2250 mm	
Fitting set (10 x screws and 10 x plugs)		Per set	21
Door drip	RAL 9016	Each	32
	Stainless steel look	Each	48
Rain canopy	Anodised aluminium		21
Pre-compressed sealing strip (width 56 mm) for groove widths between 6 – 15 mm, 5.9 m roll		Per roll	81
Offset lever height from 775 mm to 1275 mm from FFL			83
Bottom spacer profile	Height 30 mm		24
	Height 60 mm	Each	47
	Height 90 mm	Each	70
	Height 120 mm	Each	93
	Height 150 mm	Each	116

* Replaces standard fittings

Version as a security door with thermal break in resistance class RC 2

Please see your Hormann specialist dealer

MZ Thermo65 Thick Rebate – Steel

Sheet thickness 0.6 – 0.8 mm

Standard / special sizes

High thermal insulation
of up to 0.87 W/(m²·K)

Product description

- Steel door leaf overlapping the frame, with thermal break, exterior and interior in same colour
- Aluminium frame for fitting to brickwork and concrete
- Mortice lock (single locking) prepared for profile cylinder and 3 keys, without emergency and hazard function
- ▶ Ordering size = overall frame dimension (nominal size)

Colour

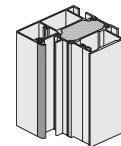

RAL 1015	Light ivory	RAL 6005	Moss green	RAL 9001	Cream
RAL 3000	Flame red	RAL 7016	Anthracite grey	RAL 9002	Grey white
RAL 3003	Ruby red	RAL 7035	Light grey	RAL 9006	White aluminium
RAL 3004	Purple red	RAL 7040	Window grey	RAL 9007	Grey aluminium
RAL 5010	Gentian blue	RAL 8003	Clay brown		
RAL 5014	Pigeon blue	RAL 8028	Terra brown		



A4 profile

Decor

Golden Oak, Dark Oak, Night Oak, Winchester Oak and Titan Metallic CH 703

View	Style description	Size (RAM)	RAL 9016	Colour	Decor
	Style THP 011 <ul style="list-style-type: none"> • 3 two-part guide rollers (180 mm), three-way adjustable with cover caps (aluminium / stainless steel lock) • Lever handle set (lever / lever) made of plastic, black, rose escutcheon ▶ Handing as specified! 	875 × 2000	1155	1362	1401
		875 × 2125			
		1000 × 2000	1185	1391	1431
		1000 × 2100			
		1000 × 2125			
1100 × 2100					
		From 700 × 1750	1514	1720	1760
		Up to 1250 × 2250			
▶ U _D -value for size 1230 × 2180 mm: 0.87 W/(m ² ·K)					
	Style THP 051 <ul style="list-style-type: none"> • 3 two-part guide rollers (180 mm), three-way adjustable with cover caps (aluminium / stainless steel lock) • 3 panes of insulated glass, exterior laminated safety glass, sand-blasted float, interior laminated safety glass • Plastic glazing frame • Lever handle set (lever / lever) made of plastic, black, rose escutcheon ▶ Handing as specified! 	875 × 2000	1544	-	-
		875 × 2125			
		1000 × 2000	1573	-	-
		1000 × 2100			
		1000 × 2125			
1100 × 2100					
		From 875 × 1875	1902	-	-
		Up to 1250 × 2250			
▶ U _D -value for size 1230 × 2180 mm: 1.0 W/(m ² ·K)					

With thermal breaks



Accessories

Door closers			
Prepared for overhead door closer (reinforcement in door leaf)			28
Slide rail overhead door closer HDC 35			161
Mechanical hold-open device		Each	61
Fittings			
			£
Lever handle set type D-110, rose escutcheon, prepared for profile cylinder	Black plastic (standard)		81
	Anodised aluminium (F1) *		177
	Brushed stainless steel *		232
Lever / knob handle set type D-110, rose escutcheon, prepared for profile cylinder	Black plastic *		123
	Anodised aluminium (F1) *		190
	Brushed stainless steel *		245
Multiple-point locking (hook bolt lock) with rose escutcheon (stainless steel lever handle / lever handle)	See dealer price list 01-17 part A, chapter Entrance Doors Thermo65		
Anti-panic fittings acc. to DIN EN 179 (opening outwards)			
			£
Single-point locking (panic lock with stainless steel cover, distance 92 mm, left-hand hinged or right-hand hinged)	With anti-panic function E		147
	With split spindle, passage function D		178
Multiple-point locking (panic lock with stainless steel cover, distance 92 mm, left-hand hinged or right-hand hinged) ▶ Possible from door height 1990 mm	With anti-panic function E		440
	With split spindle, passage function D		496
Lever / knob handle set type D-110, rose escutcheon, prepared for profile cylinder	Black plastic *		123
	Anodised aluminium (F1) *		190
	Brushed stainless steel *		245
Anti-panic lever handle set type D-110 with split spindle, rose escutcheon, prepared for profile cylinder	Black plastic *		123
	Anodised aluminium (F1) *		190
	Brushed stainless steel *		245
Profiles			
			Per m £
Extension profile 25 mm	RAL 9016		54
	Colour		63
	Decor		66
Cover Profile (package is sufficient for one door set)	RAL 9016	Per box	110
	Decor	Per box	147
	RAL 9016	Per door	226
Supplementary profile (3-sided), width 20 mm, mitred, incl. corner bracket and fitting screws	Colour	Per door	285
	Golden Oak, Dark Oak, Titan Metallic CH 703	Per door	294
Accessories			
Retractable bottom seal (frame without threshold)			259
Latch switching contact			94
Spyhole (THP 011)			47
Electric strike with day catch (separate)			75
Stainless steel bottom sheet (separate), height 110 mm	Style 011	Height RAM 1750 – 2250 mm	Each 164
	Style 051	Height RAM 1875 – 2250 mm	
Fitting set (10 x screws and 10 x plugs)		Per set	21
Door drip	RAL 9016	Each	32
	Stainless steel look	Each	48
Rain canopy	Anodised aluminium		21
Screw-in anchor set, length 280 mm (8 x anchors)		Per set	27
Pre-compressed sealing strip (width 74 mm) for groove widths between 6 – 15 mm, 5.9 m roll		Per roll	105
Offset lever height from 775 mm to 1275 mm from FFL			83
Bottom spacer profile	Height 30 mm	Each	24
	Height 60 mm	Each	47
	Height 90 mm	Each	70
	Height 120 mm	Each	93
	Height 150 mm	Each	116
Base Frame Profile	Height 15 mm	Each	24

* Replaces standard fittings

Notes and Sketches

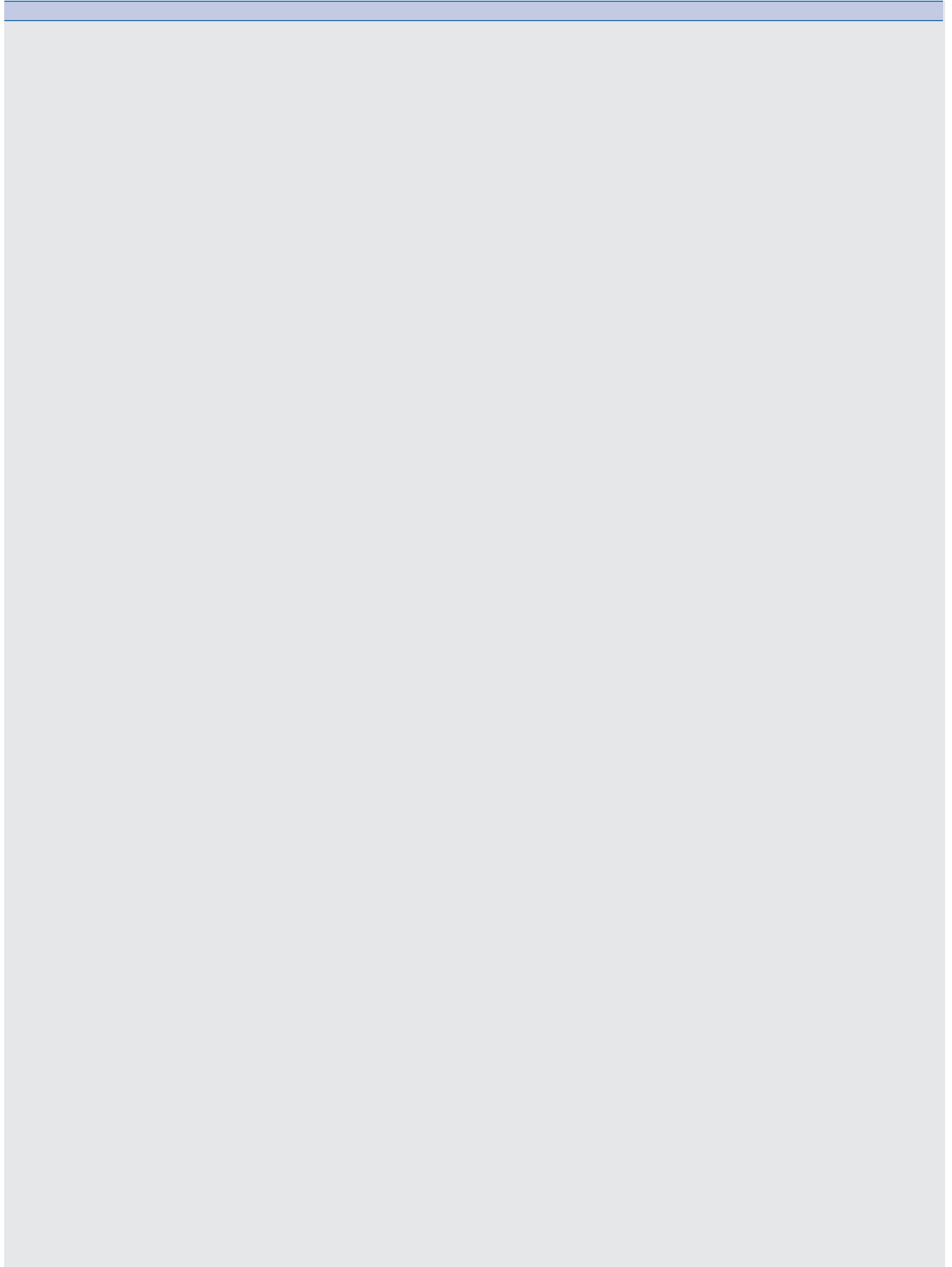

Notes and Sketches

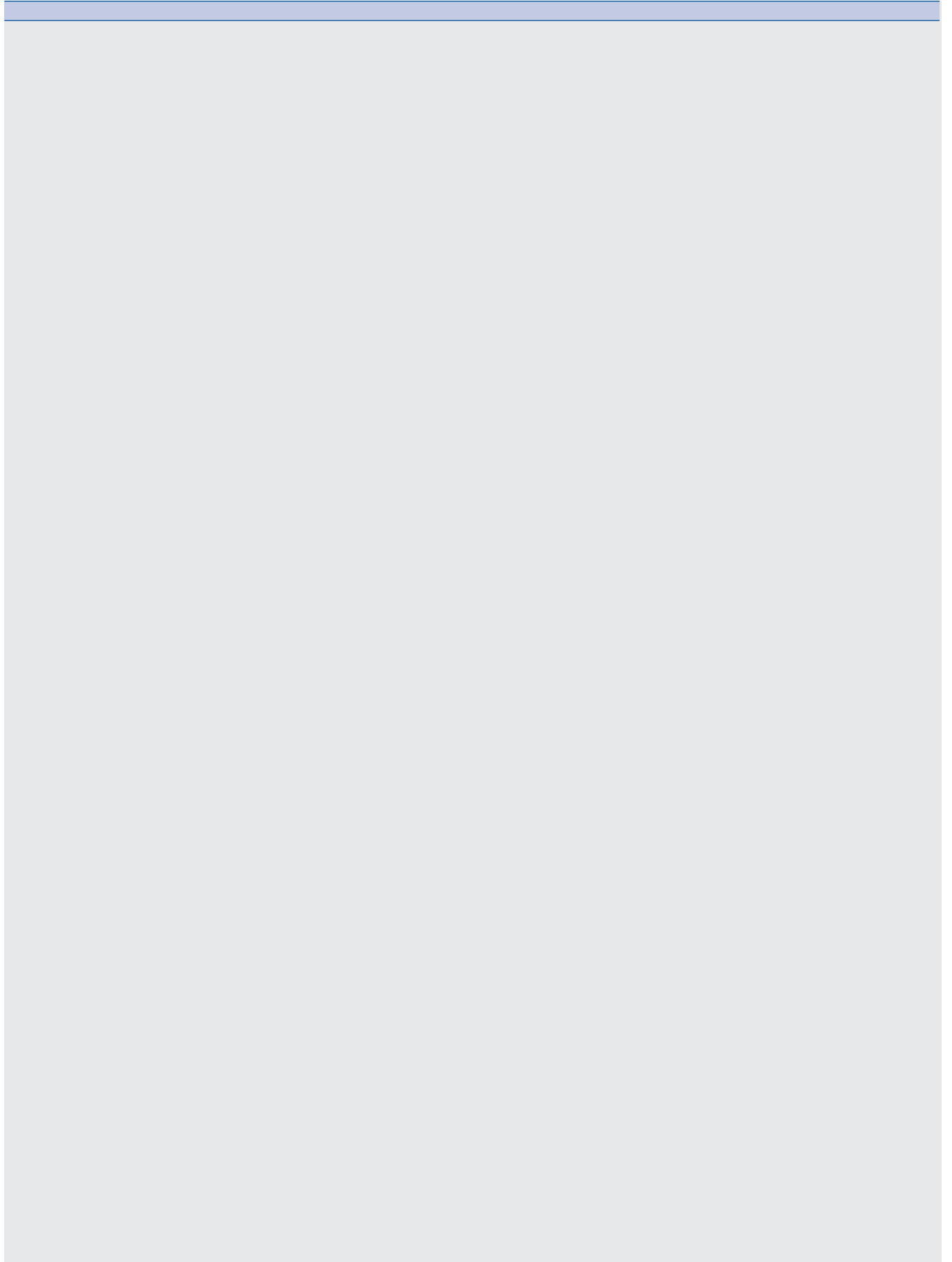

Notes and Sketches

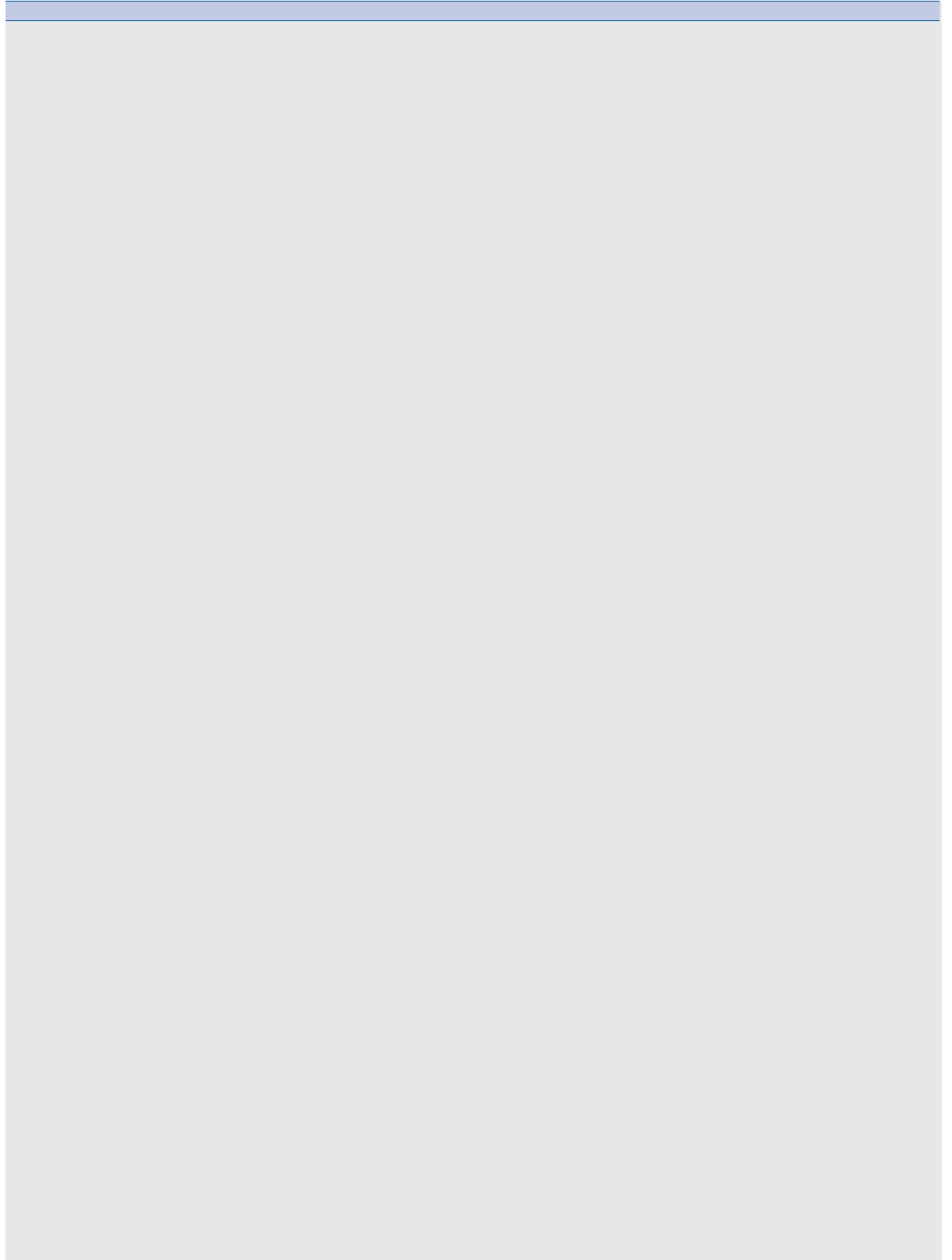

Hörmann: Quality without Compromise



Hörmann KG Amshausen, Germany



Hörmann KG Antriebstechnik, Germany



Hörmann KG Brandis, Germany



Hörmann KG Brockhagen, Germany



Hörmann KG Dissen, Germany



Hörmann KG Eckelhausen, Germany



Hörmann KG Freisen, Germany



Hörmann KG Ichtshausen, Germany



Hörmann KG Werne, Germany



Hörmann Alkmaar B.V., Netherlands



Hörmann Legnica Sp. z o.o., Poland



Hörmann Beijing, China



Hörmann Tianjin, China

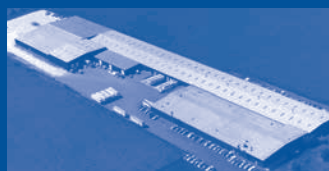

Hörmann LLC, Montgomery IL, USA



Hörmann Flexon LLC, Burgettstown PA, USA



Shakti Hörmann Ltd., India

Hörmann is the only manufacturer worldwide that offers you a complete range of all major building products from one source. We manufacture in highly-specialised factories using the latest production technologies. The close-meshed network of sales and service companies throughout Europe, and activities in the USA and Asia, make Hörmann your strong partner for first-class building products, offering "Quality without Compromise".

GARAGE DOORS
OPERATORS
INDUSTRIAL DOORS
LOADING EQUIPMENT
HINGED DOORS
DOOR FRAMES

Hörmann (UK) Ltd
Gee Road
Coalville
Leicestershire
LE67 4JW

Tel: 01530 513000
Fax: 01530 513001

www.hormann.co.uk

HÖRMANN